

THIS SHEET APPLIES TO MODELS HAVING
SERIAL NO's. 15,000 AND UP.

DESCRIPTION

PATENTED - OTHERS PENDING

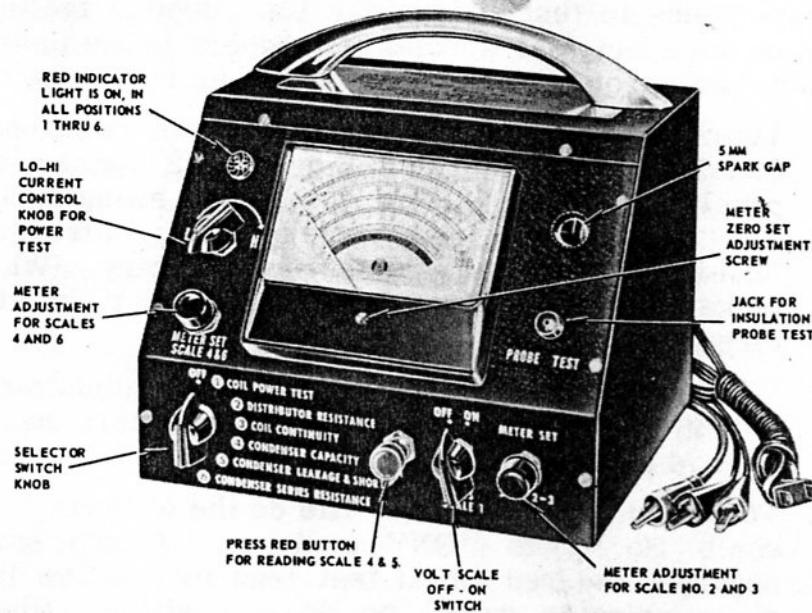

Figure 1

SERVICE NOTES

May we suggest, when testing, place Magneto Analyzer as well as Component Magneto Parts on an INSULATED OR WOODEN TABLE TOP. This will prevent any leakage or shock hazards.

Your Merc-O-Tronic Magneto Analyzer is equipped with either a motor or a vibrator. The motor has oil lite bearings and should be lubricated with a light oil once every six months. Lubricate cam wick at same time. (DO NOT OVER LUBRICATE.) If replacement of breaker point is required, order from Merc-O-Tronic Instruments Corporation as this is a special breaker assembly. Breaker points are to be set at 0.013. Pressure not to exceed 15 oz.

If vibrator fails to operate check and make certain that vibrator is in socket. When inserting vibrator, make certain pins line up with holes in socket.

NOTE: This is a special vibrator, if replacement is necessary order from your distributor or direct from factory. Merc-O-Tronic Part No. 1960-V-6593. (DO NOT ATTEMPT TO USE ANY STOCK VIBRATOR.)

Your analyzer is equipped with a Burgess 4F5H 7 1/2 volt battery. If unable to obtain locally, order direct from Merc-O-Tronic.

Be sure and specify type of battery required and serial number of unit.

OPERATING INSTRUCTIONS

For Model 98 Beginning with Serial No. 15,000

Before any attempt is made to use this instrument, read the following instructions. They were prepared to enable those having only a minimum of experience to test and repair the magneto ignition system equally as well as the electrical specialist. Adhere to the instructions in sequence. Do not jump from the first test to the fourth or the third to the fifth, etc.

1. Your Merc-O-Tronic Magneto Analyzer is shipped with a dry battery installed in the unit. Remove the 2 metal screws at the top of the panel. This will allow the top to swing back, and you will notice that the positive (red) battery lead is disconnected. Connect this lead to the positive (+) post of the battery. (When replacing battery, make certain positive terminal is to right side of tester and that terminal nuts are tight.)
2. "Zero" meter by turning the small adjustment screw on front of meter until pointer hand lines up with zero on Scale No. 1, left side. This is set at the factory, but should be rechecked.
3. To determine the battery life do the following: Move switch for volt scale No. 1 to "ON" position. Attach small black test lead to negative and red small test lead to positive lugs on battery. Then place selector switch on No. 1 position. (Red pilot will be on and vibrator will be running). Read red figures on top of Scale No. 1. Battery should check not less than 6.0 volts or proper readings cannot be obtained. (Each division on volt scale equals 0.5 volt).

For bench use this analyzer can be connected to an 8 volt storage battery power supply. For 8 volts tap off 4 cells from a 12 volt storage battery.

4. Your Merc-O-Tronic Magneto Analyzer is now ready for use.

The following batteries can be used in place of Burgess 4F5H:

Eveready 715
Neda 903

Olin 5605
RCA VS139

Ray-O-Vac 903

To check low OHM resistance values see page 18.

See Page 12B for Voltage Test Procedures.

CAUTION: DO NOT CONNECT TEST LEADS TOGETHER WHEN SELECTOR SWITCH IS TURNED TO POSITION NO. 1 AS THIS IS A DIRECT SHORT ON THE BATTERY.

FOR ALL TEST PROCEDURES INVOLVING SELECTOR SWITCHES 1 THRU 6 - VOLT SCALE SWITCH MUST BE IN "OFF" POSITION.

5. To check condenser leakage (on Scale No. 4) and condenser capacity (on Scale No. 5), plug cord into 115-volt 60-cycle AC electrical outlet. This is the only time 115-volt 60-cycle AC is required. To read, press red button, the electrical charge placed in condenser is automatically discharged when releasing red button.
6. **SPECIAL NOTICE:** When checking Lauson Power Products Coils #30546, 30560 and 29632 or any coil with internal condenser the 5 m.m. pot spark will appear fuzzy. **DO NOT** let this fuzzy spark mislead you. If spark is steady, coil is good.

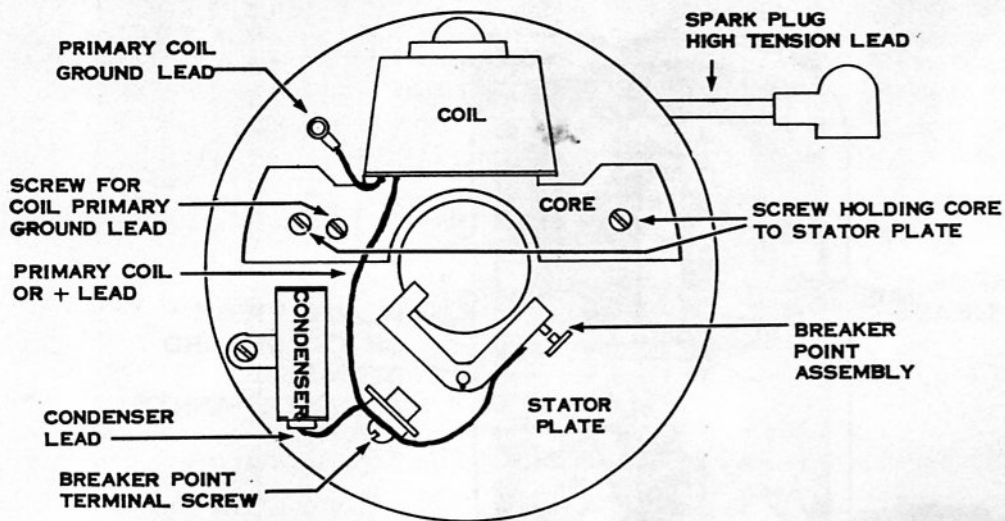

Figure 2

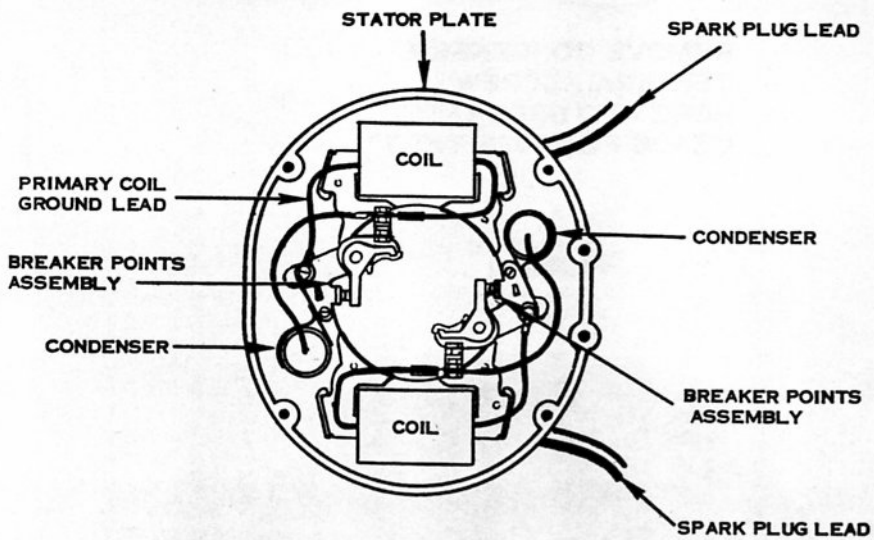

Figure 3

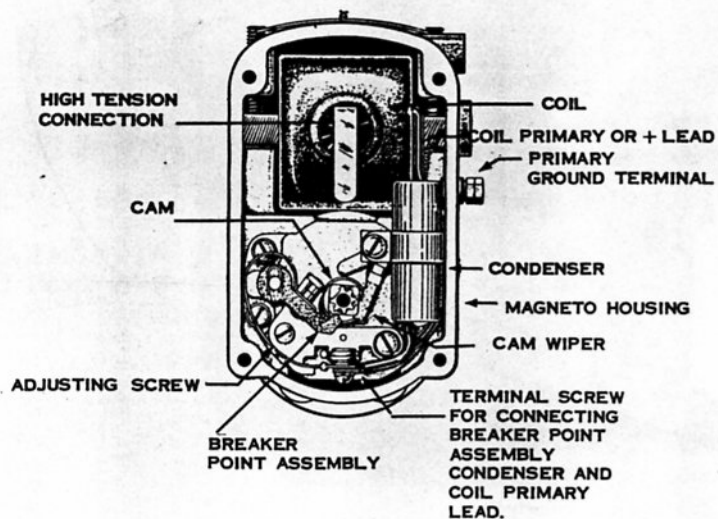
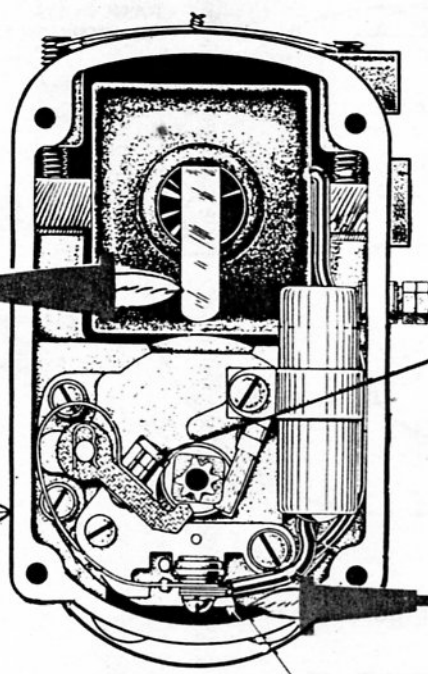

Figure 4

ATTACH LARGE
RED TEST LEAD



PLACE PIECE
OF CARDBOARD
BETWEEN
BREAKER POINTS

ATTACH
SMALL BLACK
TEST LEAD
TO HOUSING

ATTACH SMALL RED
TEST LEAD TO COIL
PRIMARY

REMOVE CONDENSER
TERMINAL SCREW
HERE AND SEPERATE
LEADS FOR THIS TEST

Figure 5

ATTACH SMALL RED
TEST LEAD TO COIL
PRIMARY

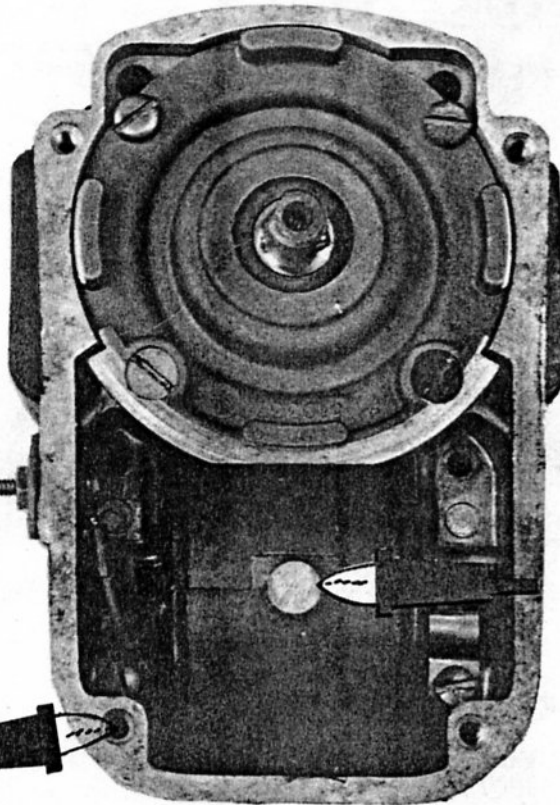

ATTACH LARGE
RED TEST LEAD

ATTACH
SMALL BLACK
TEST LEAD
TO HOUSING

Figure 6

COIL POWER TEST

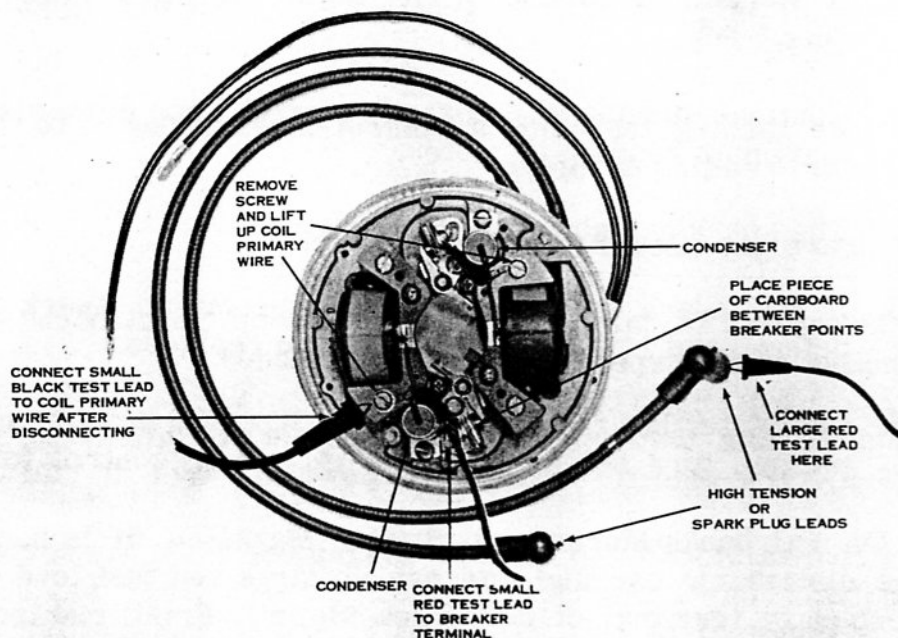

Figure 7

1. It is not necessary to remove magneto assembly from engine or parts from stator plate assembly.
2. Place a piece of cardboard between breaker points to insulate.
3. Connect small black test lead to coil primary ground wire.
4. Connect small red test lead to coil primary lead or breaker point assembly terminal.
5. Connect large red test lead to terminal of spark plug wire.
6. After wiring hookup is made, as shown in illustrations 6 or 7, the current control knob should be to extreme left, beyond "LO" position.
7. Turn selector switch to position No. 1 ("Coil Power Test").
8. Slowly turn current control knob clockwise and note the current value on Scale No. 1.
9. When it reaches the operating amperage for that particular winding, shown in this manual under Manufacturer's Specifications, stop and note the 5 MM spark gap, it should fire steadily.
10. If the spark is faint, intermittent or no spark has occurred at this reading, the coil is defective and must be replaced.
11. If a steady spark occurs below Manufacturer's Specifications, this indicates a very good coil.

COIL HIGH SPEED TEST

12. If the coil is good on Coil Power Test, preceding, perform the High Speed Test.
13. Continue turning the current control knob clockwise to the right, for maximum reading of meter.
14. The spark gap should fire steadily.
15. If the spark is faint, intermittent or no spark occurs, the coil is defective at high speed and must be replaced.
16. Complete this test as quickly as possible and immediately upon completion, turn selector switch and power control to "OFF" position.

On Fairbanks-Morse and similar Magnetos, it is necessary to remove the distributor cap and end cap so large red test lead can be attached to secondary terminal of coil "see Fig. 5". Small red test lead is attached to coil primary lead after the lead has been removed from breaker point terminal. The small black test lead is attached to housing "see Fig. 5".

When checking coil on stator plate with crankshaft type high inductance rotating magnet (i.e. Wico, Scintilla and similar type magnetos), be sure rotating magneto is in neutral position (magnets not opposite the coil core).

NOTE: When testing coils off stator plate, it is absolutely necessary that the laminated core be in the coil.

NOTE: On Fairbanks-Morse and similar type magnetos, the coil primary lead must be removed from breaker point terminal during this test. This also applies to all coils which are permanently grounded to laminations. See Figure 5.

Coils with Two (2) Secondaries Testing, see Page 21.

Stator plate with 2 coils mounted, each coil to be checked separately as noted in Fig. 7.

NOTE: All coils should start firing 1 to 3 divisions before rated specifications. Coils which first start to fire on "rated" specifications are considered marginal and would give considerable trouble in starting engine and should be considered as defective.

COIL SURFACE INSULATION TEST

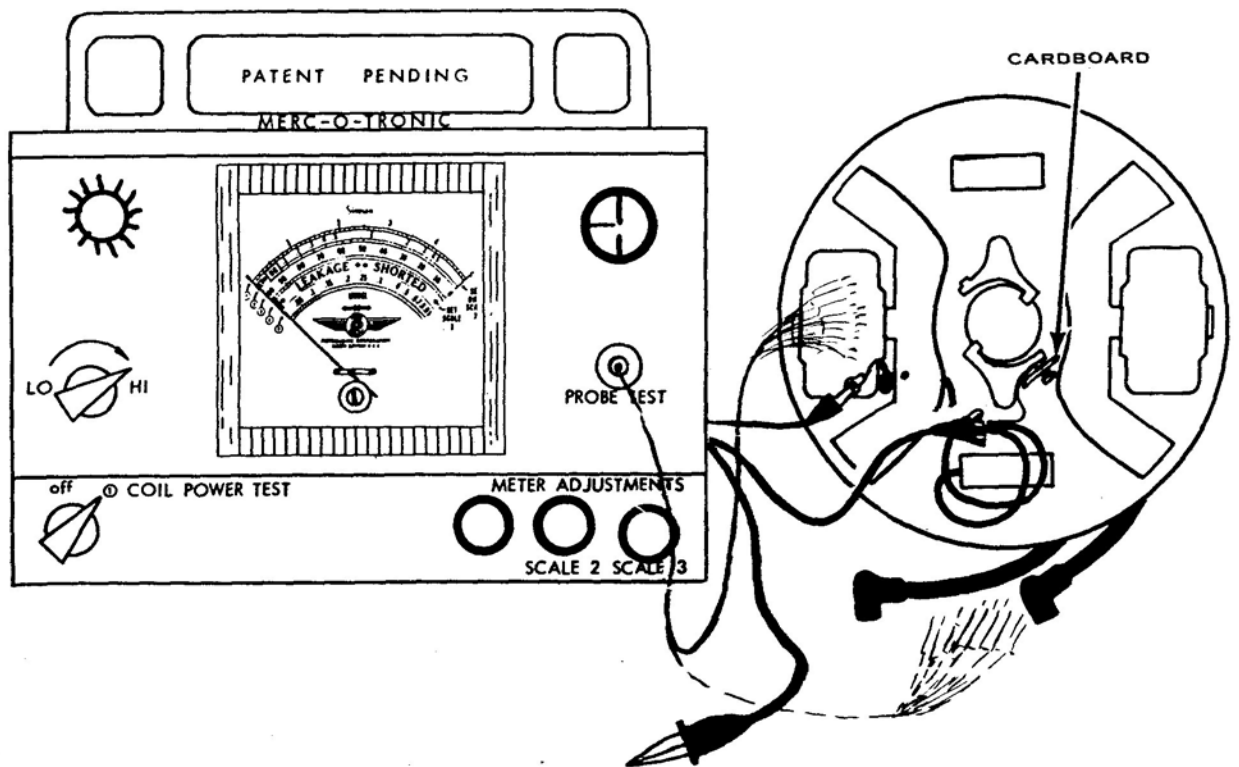

Figure 8

1. Remove large red test lead from coil secondary, (High Tension lead) see illustration Fig. 8.
2. Small red and black test leads stay connected as previously.
3. Plug insulation test prob into "JACK" on front of tester.
4. Turn selector switch to position No. 1.
5. Turn current control knob to "HI" position for maximum current reading on meter. "Do not exceed meter reading."
6. Pass end of insulation test probe over the insulating surface of the coil and spark plug wires.
7. If coil insulation is cracked, leaking or damaged, a spark discharge will be noted at the cracked or leaking surface.
8. Do not permit test probe to linger too long at any point while conducting this test.
9. Completing test as rapidly as possible, as this is a severe test on a coil.

A faint spark occurring around coil insulation during probing is a corona spark and does not illustrate a defective coil.

COIL CONTINUITY TEST

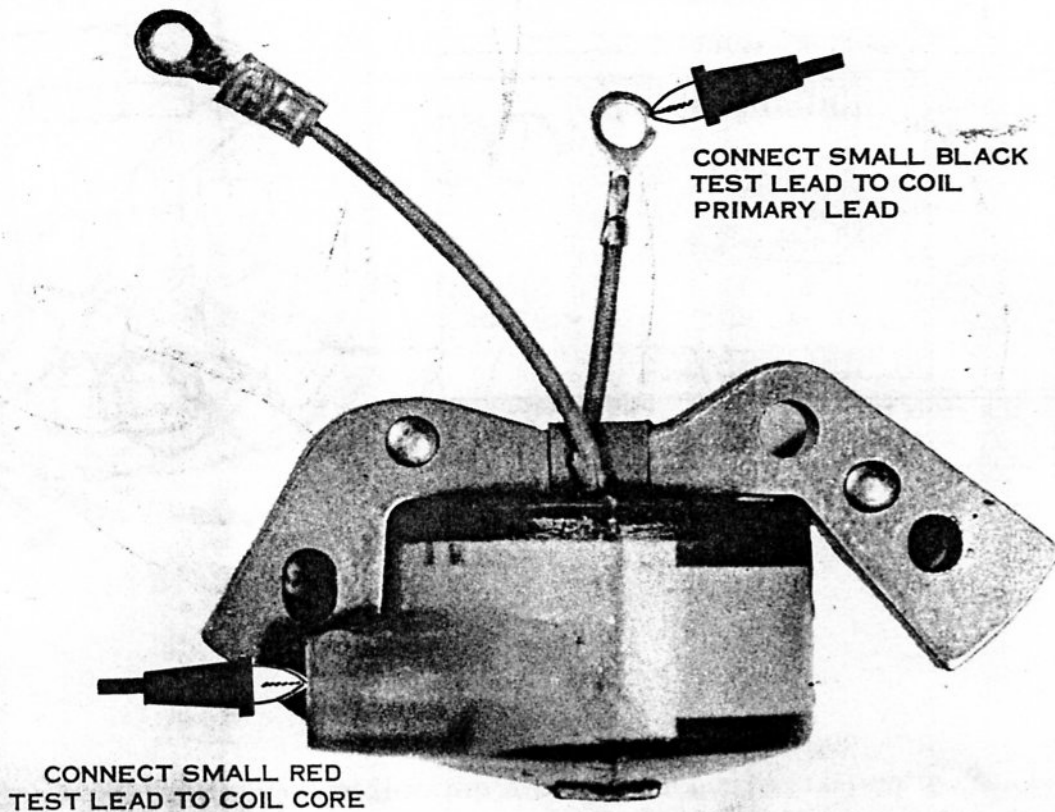

Figure 9

NOTE: Scale 3 has two scales. The upper number is the number shown on Mfg. specifications or are comparative numbers in place of actual ohm resistance "lower numbers." This is an added feature to our later model units starting with Serial No. 4050.

1. Turn selector switch to position No. 3 Coil Continuity.
2. Clip small red and black test lead together.
3. Turn meter adjustment knob for scale No. 3 until meter pointer lines up on set position on right side of scale No. 3.
4. Connect small black test lead to coil ground wire as in previous test.
5. Connect small red test lead to spark plug "high tension" lead.
6. Reading must be between the two values for that particular coil shown in this manual under manufacturer's specifications.
7. Reading of actual resistance in ohms can be obtained by reading lower numbers in same scale.
8. Readings lower than the lowest value under manufacturer's specifications, the secondary winding is shorted.
9. Readings higher than the highest value shown in the specifications, the secondary winding is open.
10. In either case, the coil is defective and must be replaced.

COIL GROUND TEST

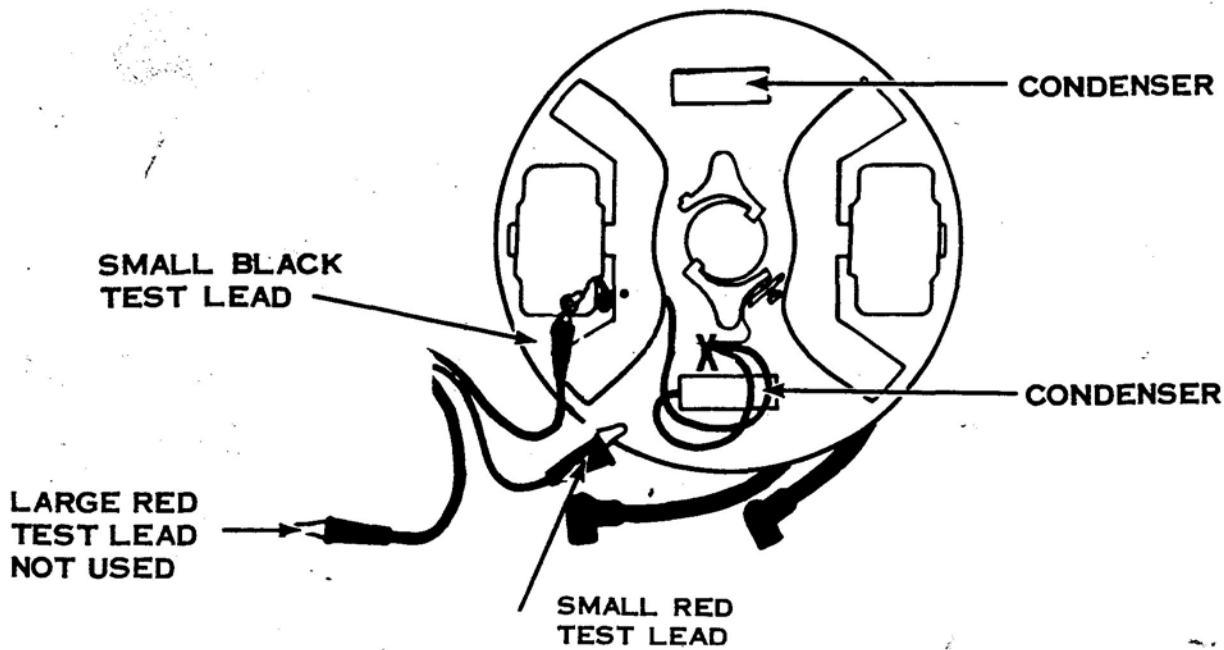

Figure 10

1. Leave small black test lead connected as in Coil Continuity Test.
2. Remove small red test lead from high tension wire and connect it to ground or frame of stator plate. (See wiring hookup, Fig. 10.)
3. Turn selector switch to position No. 3 and read Scale No. 3.
4. The meter pointer hand must be on the "ZERO" line at the left.
5. Any meter movement to the right indicates a grounded coil.
6. If there is a meter pointer hand movement to the right, indicating a grounded coil, remove the breaker point terminal screw at "X" on diagram Fig. 10.
7. Remove primary coil wire at this point. If the meter needle remains to the right the trouble is elsewhere.
8. Check condenser for short or grounded breaker points.

NOTE: When coils are permanently grounded to lamination (i.e., Fairbanks-Morse, Bendix-Scintilla), see illustration and similar type Fig. 11, it is not possible to check for ground. This type of coil must indicate a ground (movement of meter pointer hand to full right).

NOTE: When coils are not permanently grounded to lamination, it is possible to check for ground. This type of coil must not indicate any movement of meter pointer hand.

CONNECT SMALL BLACK
TEST LEAD TO COIL CORE

CONNECT SMALL RED
TEST LEAD TO COIL
PRIMARY LEAD

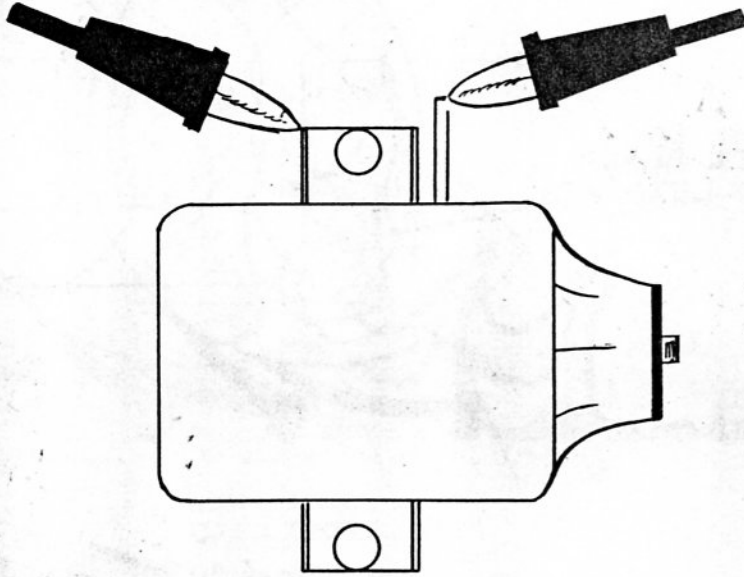

Figure 11

AUTOMOTIVE TYPE COILS

To test automotive type coils, place small red test lead to positive (+) terminal of coil and small black test lead to ground (-) terminal of coil. Place large red test lead into secondary high tension (plug in terminal) of coil. Follow procedure for testing coils on Pages 5 and 6 and refer to illustration Fig. 13 showing insulation test on automotive coil.

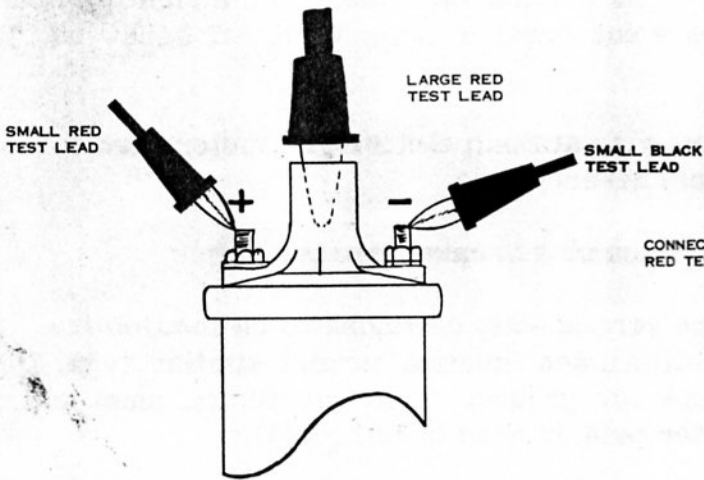

Figure 12

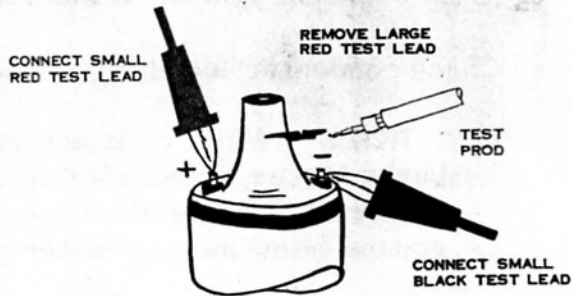
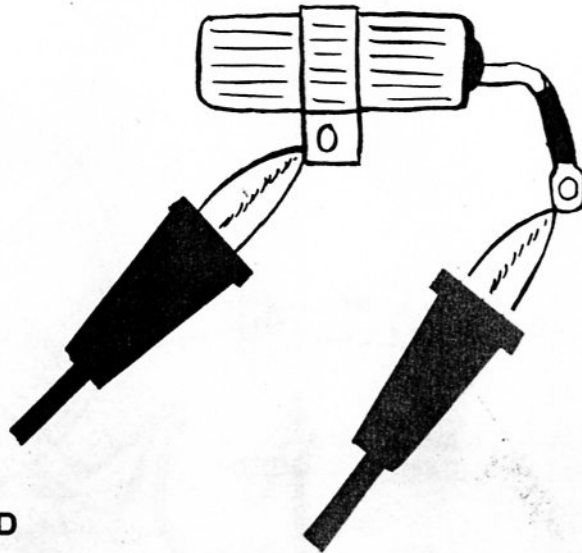

Figure 13

CONDENSER CAPACITY TEST



**CONNECT SMALL
BLACK TEST LEAD
TO HOUSING**

**CONNECT SMALL
RED TEST LEAD**

Figure 14

1. To make condenser test, cord must be plugged into 115 volt 60-cycle AC outlet.
2. Leave cardboard between breaker points.
3. Place selector switch on position No. 4, condenser capacity.
4. Clip small red and black test leads together.
5. Depress red button, turn meter adjustment knob on scale 4 to set line on scale No. 4 on right side of meter. (This adjustment is for varying line voltages throughout the country.)
6. Unclip test leads.
7. Connect small red test lead to breaker terminal or if loose to condenser lead.
8. Connect small black test lead to stator plate if condenser is mounted, otherwise to body of condenser. (Depress red button to read Scale 4.)
9. Condenser must be within manufacturer's specification for this particular motor.
10. If not, replace as a condenser that is over or under capacity could cause burnt breaker points.

CONDENSER LEAKAGE AND SHORT TEST

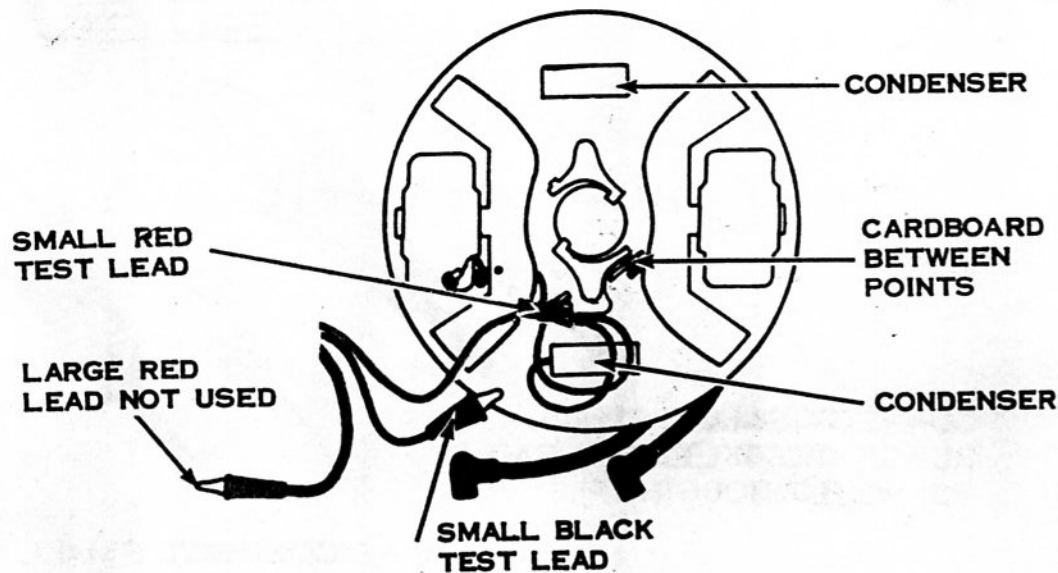

Figure 15

1. Connect small black test lead to stator plate if condenser is mounted, otherwise to body of condenser.
2. Connect small red test lead to breaker terminal, or if unmounted, to condenser lead.
3. Leave cardboard between breaker points.
4. To make condenser test, cord must be plugged into 115 volt 60-cycle AC outlet.
5. After wiring hookup is made, turn selector switch to No. 5 "Leakage" and short.
6. Depress red button and hold a minimum of 15 seconds. Read Scale No. 5.
7. The meter pointer hand will move to the right and must return within range of the narrow black bar at the left.
8. Any readings to the right of the black bar indicate the condenser is leaking or shorted and must be replaced.

NOTE: On Fairbanks-Morse type magnetos or equal, the condenser lead must be removed from the breaker point terminal when testing on a complete magneto. Condenser should be taped against an insulated board while testing to show up loose element.

CONDENSER SERIES RESISTANCE TEST

1. Leave cardboard between breaker points.
2. Place selector switch on position No. 6 condenser series resistance.
3. Clip small red and black test lead together.
4. Adjust meter set scale 6 to set line on right side of dial for scale No. 6.
5. Unclip test leads.
6. Connect small red test lead to breaker terminal or if loose to condenser lead.
7. Connect small black test lead to stator plate if condenser is mounted otherwise to body of condenser.
8. Meter pointer must be within ok green block on scale No. 6 on right side of meter.
9. While testing move and "wiggle" the lead coming out of the condenser.
10. Observe meter pointer for any movement.
11. Loose connections can cause trouble if the condenser is subjected to a great deal of vibration.
12. If meter pointer remains within ok green bar on scale No. 6 the condenser is good.
13. If meter pointer moves into the red section on Scale 6 or if by wiggling the condenser lead it moves into red section, then the condenser is defective.
14. This test usually helps to determine the ability of the condenser to readily charge and discharge.

NOTE: This test is very sensitive, as the latest techniques are being used for this test.

DUE TO THE SENSITIVITY OF THIS TEST, MAKE CERTAIN TEST CLIPS AND PARTS THAT TEST CLIPS ARE ATTACHED TO ARE CLEAN OR FALSE READINGS WILL BE OBTAINED.

VOLTAGE AND COIL POWER TEST INFORMATION

Use the two small test leads (Red and Black) for checking voltage readings from 0 - 24 volts maximum. Small red lead is positive and black lead is negative.

Scale No. 1 is actually two scales in one. The red scale is for checking voltage. Each red line or division represents 1/2 volt with a maximum reading of 24 volts. Do not attempt to check voltage if selector switch is on any other position than "OFF" except when checking battery in analyzer. Voltage can only be checked when volts Scale No. 1 switch is in the "ON" position.

THE BLACK SCALE IS FOR CHECKING AMPERAGE DURING THE COIL POWER TEST ONLY. Each black division on the scale represents 1/10 of an amp., with the black 1 representing 1 amp. etc up to maximum of 4 amperes. Amperage during coil power test can only be read when The Volts Scale No. 1 switch is in the "OFF" position.

NOTE

When voltage switch is in "ON" position, analyzer is inoperative on all other tests. Be sure to place volt switch in "OFF" position for other tests on analyzer. Do not attempt to use volt scale for ammeter readings.

BREAKER POINT TEST

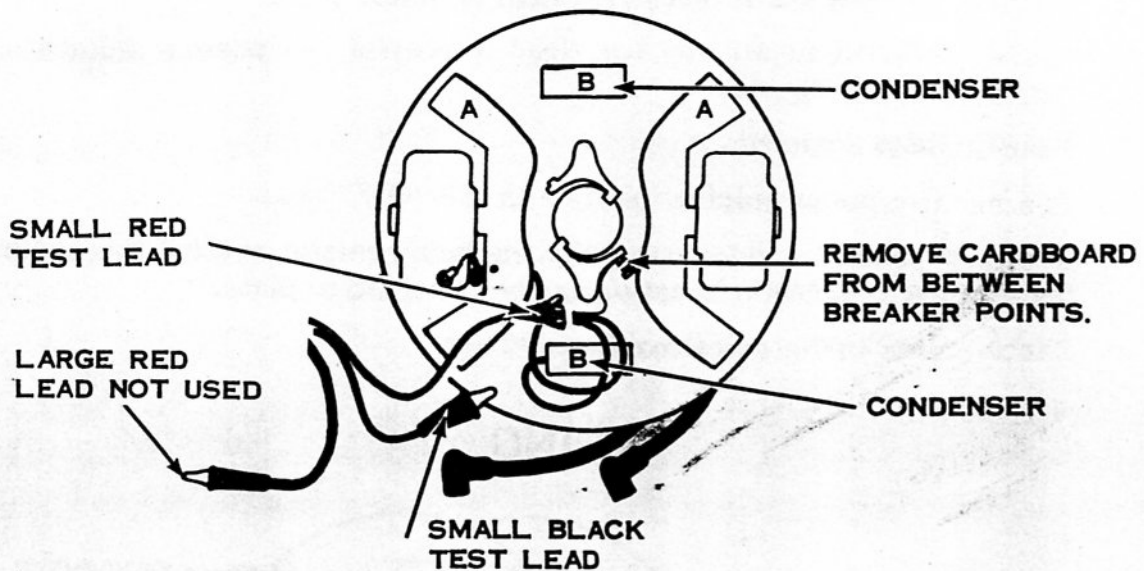

Figure 16

TESTING FOR HIGH RESISTANCE IN PRIMARY CIRCUIT

1. Turn selector switch to position No. 2 Distributor Resistance.
2. Clip small red and black test leads together.
3. Turn meter adjustment knob for scale No. 2 until meter pointer lines up with set position on left side of "OK" block on scale No. 2.
4. Unclip small red and black test leads.
5. Connect small red test lead to breaker point terminal.
6. Connect small black test lead to stator plate or any part of engine per illustration No. 16.
7. Turn crankshaft until cam allows breaker points to close.
8. The meter pointer must return in the "OK" block.
9. If the meter pointer is in the high resistance band, this indicates that there is foreign matter between breaker points.
10. See note.
11. Breaker assemblies not meeting this test should be replaced.

NOTE: Although breaker points are made of non-corrosive metal a current resisting tough film may form after the engine stands for a period of time, especially if stored in a damp place. This film will cause hard starting of the engine. By running a piece of stiff paper (such as a business card) between the points under tension several times, the film will wear and dirt or oil will be removed from between the breaker points. After cleaning points in the above manner, the meter hand should be in the "OK" block. If not, replace breaker points.

TO CHECK CONDENSER FOR PROPER GROUNDING

1. Connect small black test lead to stator plate.
2. Connect small red test lead to body of condenser. Point B see illustration Fig. 16.
3. Read Scale No. 2.
4. The meter pointer must be in the "OK" band.
5. If meter pointer reads in the high resistance band this indicates that the condenser is not properly grounded to plate.
6. Check points in the same manner.

TIMING

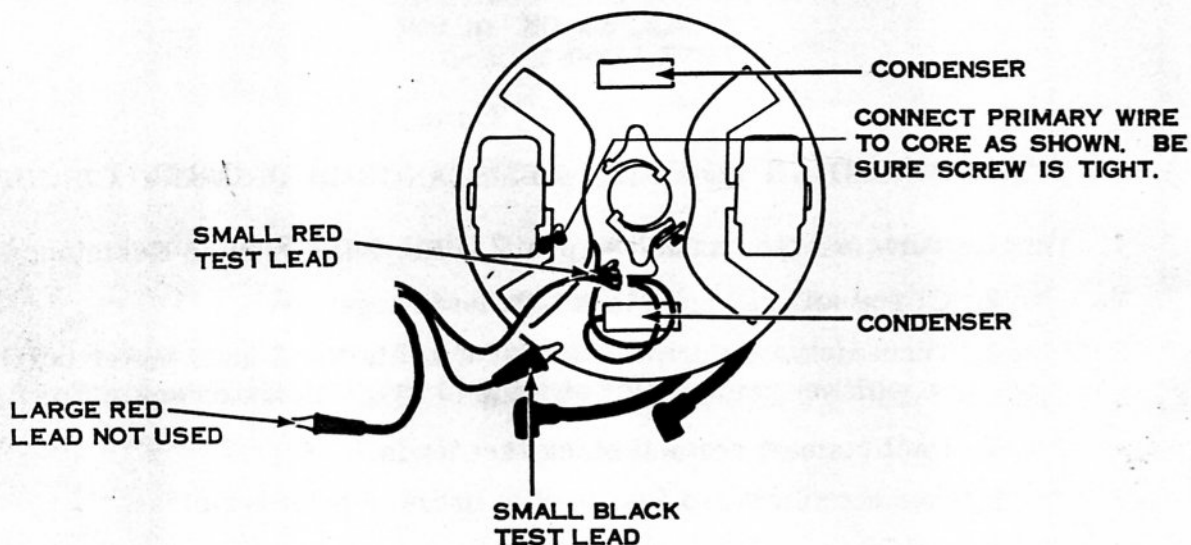

Figure 17

BEFORE TIMING

Preliminary to timing motor, set the breaker points to the manufacturer's specifications. Use a feeler gauge -- don't guess. Be sure the breaker rubbing block is on the highest part of the cam when setting points. (Refer to "Breaker Point Test", preceding.) Lubricate the cam oiler wick of the breaker arm with fibre grease (as specified by manufacturers). Be sure the moveable arm is free on pun and lubricate pivot pin with fibre grease. Be sure all screws are tight and that all wires are in their proper place.

TIMING

1. Remove paper from between breaker points and clean points before test. DO NOT FILE.
2. Connect small black test lead to the stator plate frame.
3. Connect small red lead to the breaker point terminal screw.

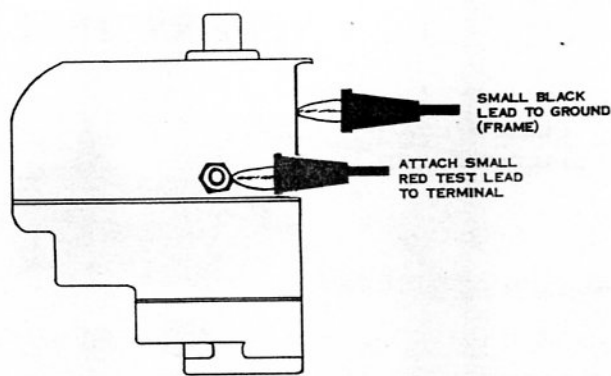

Figure 18

“See your manufacturer’s service manual for the particular motor specification relative to piston movement with timing of magneto.” Set this first.

Again, be certain that the breaker points are making perfect contact. Refer to “High Resistance Test in Primary Circuit”, preceding. After wiring hookup is made, as shown in illustration preceding, turn selector switch to position No. 2, “Distributor Resistance”, and read Scale No. 2. Rotate magneto or distributor in the advance direction. It will be noted, when points are closed, that the meter pointer hand will be in the “OK” block. The moment that the breaker points start to open, the meter pointer hand will move into the high resistance band. In this manner, the timing can be set in relation to movement of the piston.

On magnetos, such as Fairbanks-Morse or Kiekhaefer type, connect the small red test lead to the exposed primary ground terminal and the black lead to the frame or ground. See Fig. 18.

ARMATURE GROUND TEST

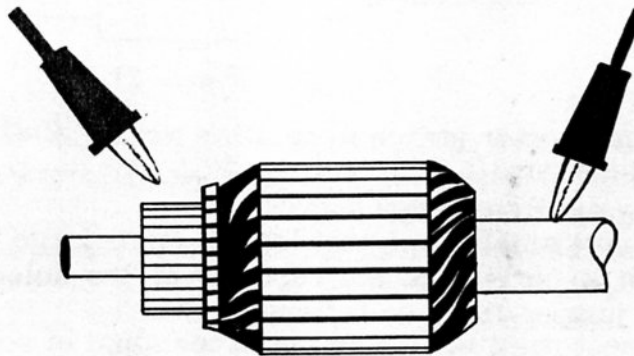

Figure 19

Turn selector switch to position No. 3, “Coil Continuity”. Attach small black test lead to armature shaft, as shown in illustration above, and use small red test lead to probe the commutator copper divisions. If the pointer hand moves across the meter to the right, as the divisions are contacted, the armature is grounded and must be replaced or commutator must be cut down and mica must be undercut. Meter pointer hand should not move during this test.

SPARK TEST

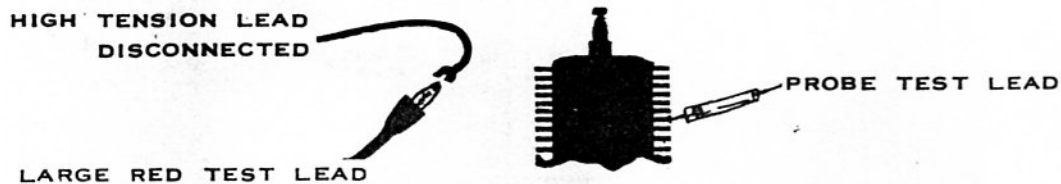

Figure 20

With the selector switch in "OFF" position, disconnect the high tension lead from the spark plug and clip large red test lead to spark plug lead. Place test probe into red jack and attach opposite end to cylinder block to form ground. Crank engine over and view spark jump through tester's small window. If no spark, indications are that some part of the magneto is defective or lead wire is broken. Repeat process for each spark plug lead wire.

NOTE: IF SELECTOR SWITCH IS IN ANY OTHER POSITION, DAMAGE TO METER WILL RESULT.

STARTER SOLENOID TEST

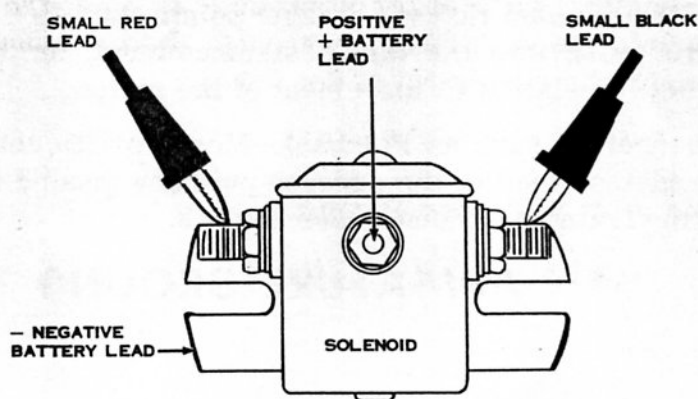

Figure 21

1. Turn selector switch to position No. 3, "Coil Continuity".
2. Connect small red test lead to one large terminal of solenoid, as shown in illustration above.
3. Connect small black test lead to other large terminal of solenoid.
4. With a battery of the capacity of the solenoid (6 or 12 volts), place two jumper leads on battery terminals.
5. Connect positive lead to small terminal of solenoid.
6. Connect negative lead to case or bracket of solenoid for ground.

NOTE: On solenoids with two small terminals, one is a ground and one an energized terminal.

7. Meter pointer hand must move fully to right of meter.
8. If no movement or only partial movement is indicated, the solenoid is defective and must be replaced.

CAUTION: DO NOT CONNECT BATTERY LEADS TO LARGE TERMINALS OF SOLENOID OR METER WILL BE DAMAGED.

CONTINUITY TEST

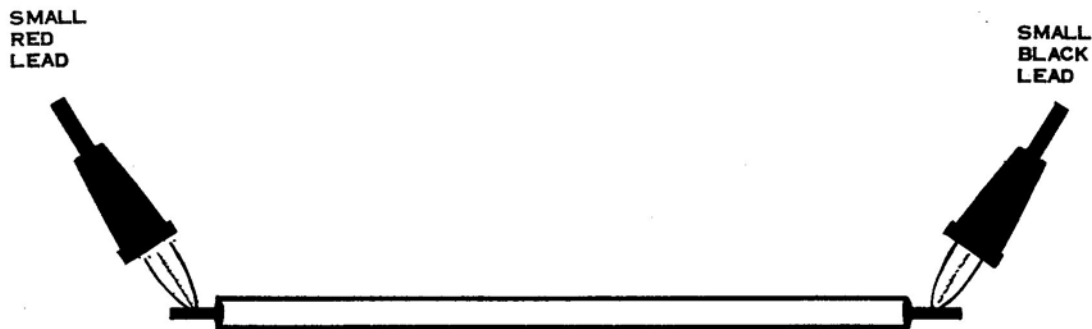

Figure 22

To test ignition or electrical wires and harness or parts for "open circuits", turn selector switch to position No. 3, "Coil Continuity" Zero out meter. Connect small black test lead to one end of wire and small red test lead to opposite end of same wire, as shown in illustration above. Meter pointer hand must move fully to the right of meter. If meter pointer hand stays at left, this indicates a broken wire. Move lead wire back and forth while making test.

RESISTANCE TEST

To check an electrical harness and wire terminals to determine if the part is OK, place selector switch on Scale No. 2, "Distributor Resistance". Attach small red test lead to terminal of one end of lead and small black test lead to other end. Meter pointer needle must return to "OK" block. If needle favors right side away from "OK" band it indicates a defective connection inducing a resistance. Repair connection or replace part.

RESISTOR TEST

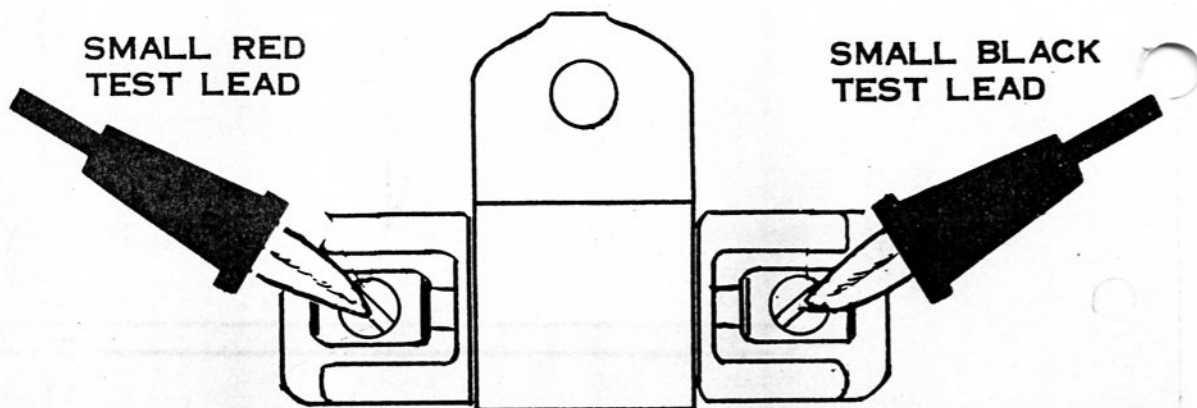

Figure 23

Use scale No. 2 for checking low OHM resistance values. Set selector switch on No. 2, "Distributor Resistance", position. Do not clip test leads together. Turn No. 2 scale meter adjustment knob to adjust meter needle with red line on right side of Scale No. 2. Your meter is now set to check all low OHM values from 0 to 30 OHMS. Clip small red and black test leads to terminals of resistor, as shown in illustration above, and read red figures on Scale No. 2. Replace resistor not meeting the manufacturer's specifications.

Manufacturer	Part No.	Resistance Reading	
		Min.	Max.
Kiekhaefer Mercury	393-1286	1.3	1.7
Kiekhaefer Mercury	393-1482	2.0	2.4
Kiekhaefer Mercury	393-1572	3.0	3.4
McCulloch (Scott)	332-196	1.7	1.9

HIGH TENSION LEAKAGE - CRACK TEST

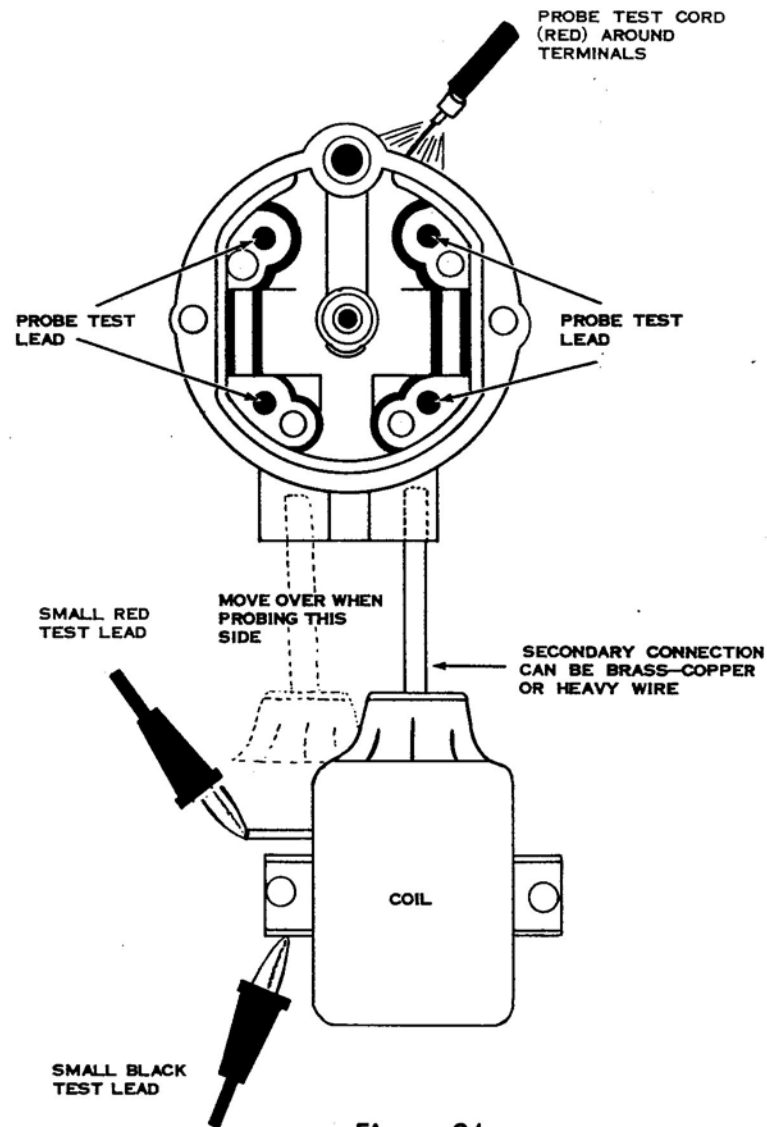

Figure 24

To check for cracks or leakage paths in ignition distributor caps or distributor rotors, clip small red test lead to coil primary lead and black test lead to coil core, as shown in illustration above. A used coil is best for this test, since the coil will be used for inducing a high secondary voltage. The secondary coil terminal must have a brass or copper lead attached so that it will extend fully into the distributor cap spark plug lead wire outlet to provide the spark for this test. Turn selector switch to position No. 1, "Coil Power Test", and turn "LO-HI" current control knob to the "HI" position. Place test probe into jack in tester and pass other end of test probe over area around distributor contact post. If there is a crack or leakage path, it will show up by the spark following a path in the cap rather than sparking directly to the correct terminal. If the spark path occurs, the cap is defective and must be replaced. There should be no spark jump to any other distributor post other than the one being tested. Repeat procedure on each contact post of distributor cap.

DISTRIBUTOR ROTOR TEST

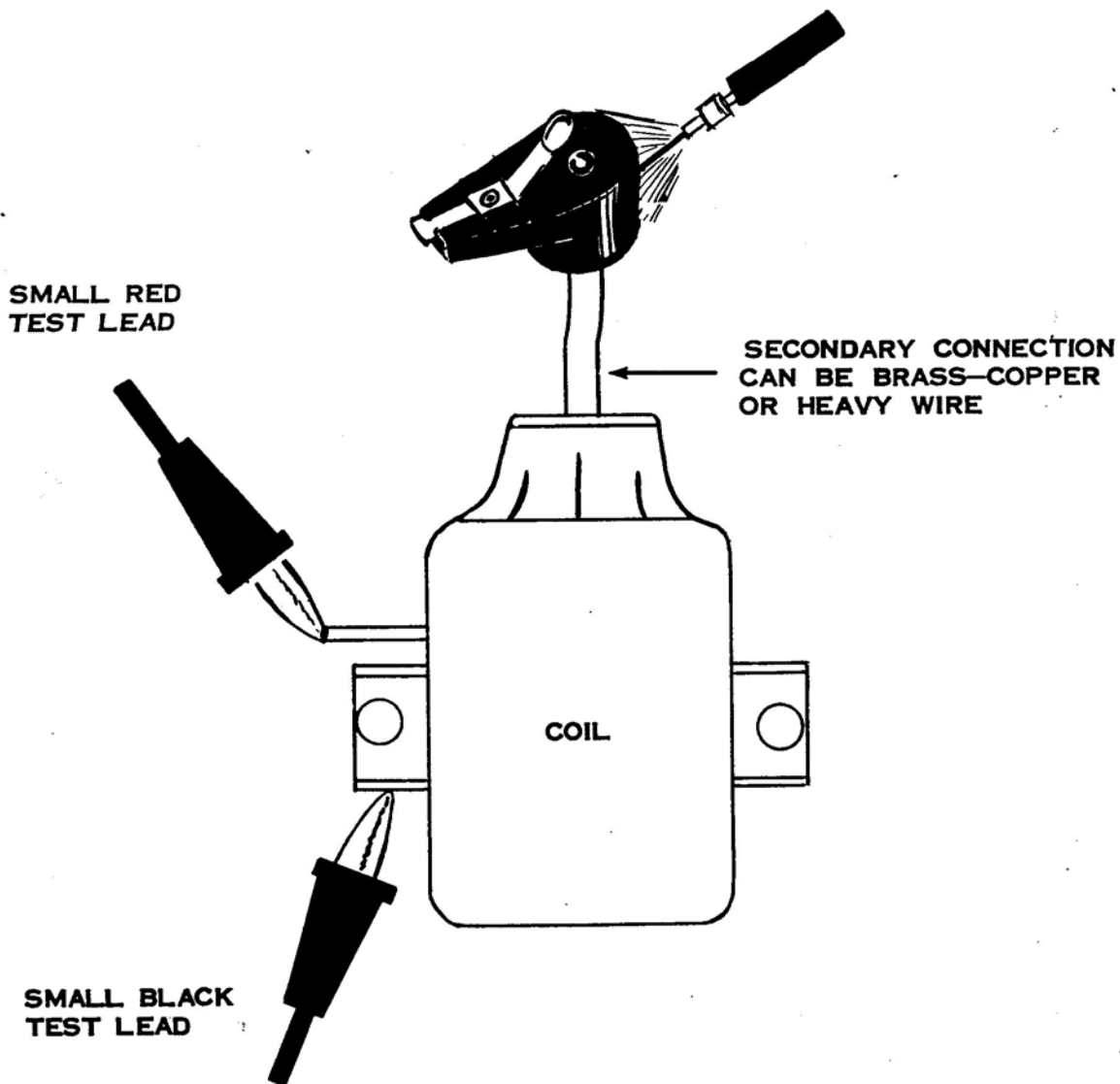

Figure 25

Follow distributor cap leakage test procedure, preceding. Place distributor rotor on high tension terminal of coil so that rotor shaft hole rests on coil terminal as shown in Figure 17. Search around distributor rotor with ground test probe. There should be no spark jump at any point. If a heavy spark does occur, it indicates a defective distributor rotor. Replace defective part.

TESTING COILS WITH TWO SECONDARIES

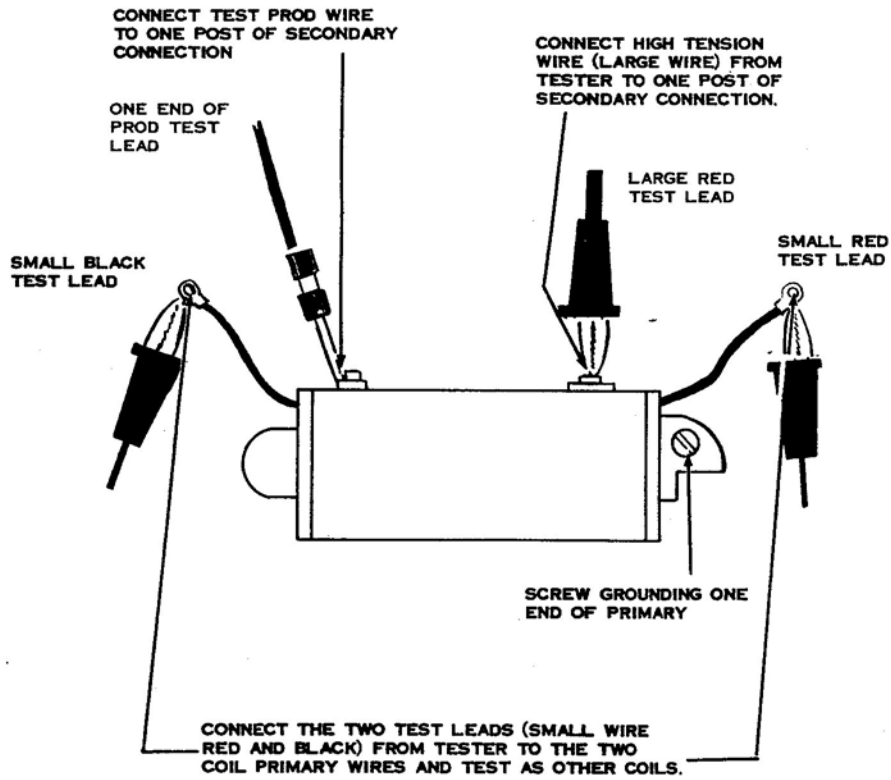

Figure 26

TESTING CONVENTIONAL TYPE MAGNETO

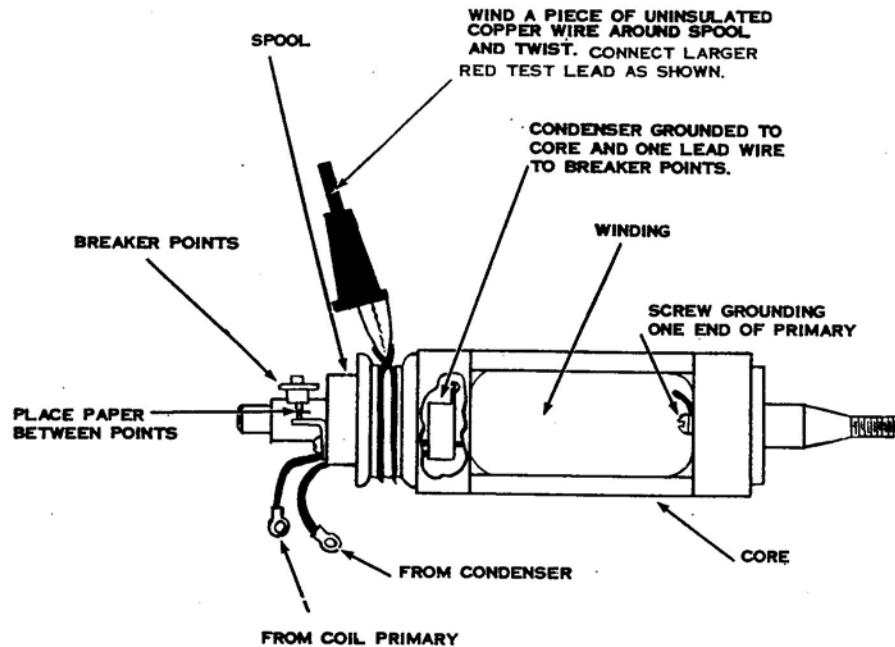

Figure 27



Figure 28

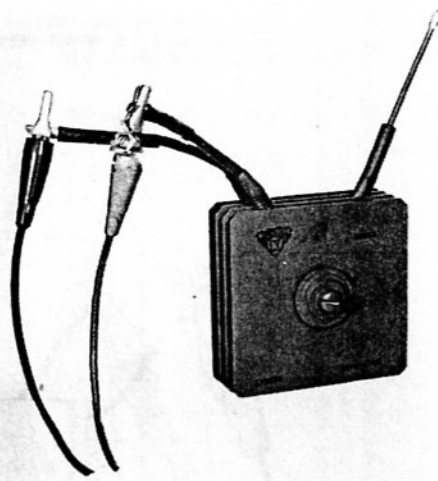

Figure 29

TESTING SELENIUM RECTIFIERS

BY MEASURING DIRECT CURRENT RESISTANCE

1. Set selector switch on position No. 3, "Continuity".
2. Clip small red and black test leads together and turn meter adjustment knob for Scale No. 3 until meter pointer lines up on set position on Scale No. 3, right side.
3. Connect small red test lead to positive lead on rectifiers. Figure 28.
4. Connect small black test lead to ground stud or lead on rectifier. Figure 28.
5. Note reading of figures on lower band, Scale No. 3.
6. Reverse test leads on rectifier and note readings again.
7. Ratio of two readings should be 10:1 or greater.
8. Remove analyzer test leads and connect to the two alternator leads or lead terminals on rectifier. Figure 29.
9. Note reading of figures on lower band, Scale No. 3.
10. Reverse test leads on rectifier and note readings again.
11. The ratio of the two readings should be no more than 2:1.
12. This is only a preliminary test to determine condition of rectifier. If questionable, as a final test, rectifier should be installed on engine and checked with ammeter while engine is running.

NOTE: This is a true ohm scale, 0 - 200,000 ohms and can be used to test ohm resistance of other electrical components.

FIELD WINDING GROUND TEST



STARTER MOTOR DISASSEMBLED

1. Turn selector switch to position No. 3, "Coil Continuity".
2. Attach small red test lead to insulated terminal on outside of starter motor and small black test lead to starter motor frame.
3. Meter hand should not move, if it does, it indicates the field is grounded.
4. On starter motors having two fields 1) forward winding 2) reverse windings, test both insulated terminals.

GROUND BRUSH TEST

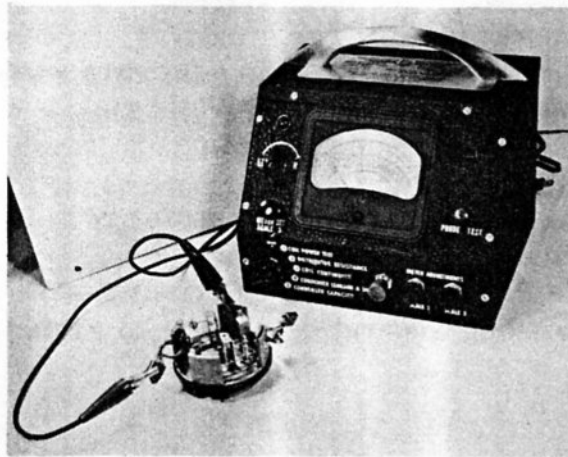

STARTER MOTOR DISASSEMBLED

1. Turn selector switch to No. 3, "Coil Continuity".
2. Attach small black test lead to the grounded brush and small red test lead to frame to which brush is fastened. (End cap housing or field frame.)
3. Meter hand must move to the right, if not, there is a poor ground connection.
 - a) replace the ground brush and lead or
 - b) check that the lead connection is secure to the frame.
4. There is also a possibility of the brush holder having a poor ground to the frame or end cap, test by following steps 1, 2, 3 above.

GROUNDING ARMATURE OR FIELD WINDING



STARTER MOTOR ASSEMBLED

1. Raise ground brushes from commutator and insulate them from commutator with cardboard. Make sure brush is not touching commutator.
2. Turn selector switch to position No. 3, "Coil Continuity".
3. Attach small red test lead to insulated terminal on outside of starter motor and small black test lead to starter motor frame.
4. On starter motors having two fields 1) forward winding 2) reverse windings, test both insulated terminals. While making test move brush lead, making sure there is a solid connection.
5. If analyzer shows continuity (meter hand moves to the right) there is a ground, check individually (a) and (b) below:
 - a) Check armature - Page 15 Armature Ground Test.
 - b) Check fielding winding separately - Page 23 Field Winding Ground Test.

SERVICE SECTION

(PAGES 24A — 24L)

FOR

EVINRUDE - JOHNSON

UNI-CHARGER

or

AC GENERATOR

-ALTERNATOR

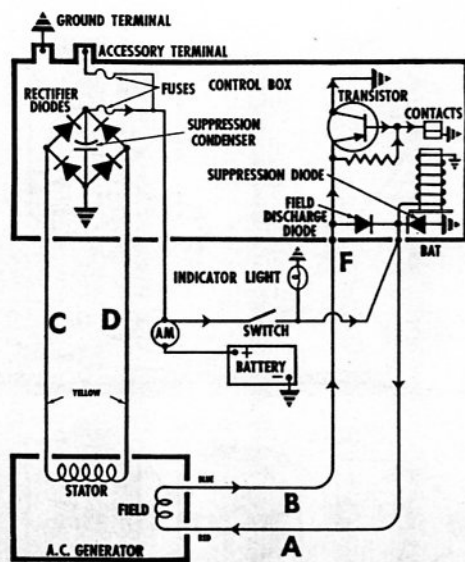

Figure 30

TESTING FOR FAULTY WIRING

1. A short between two wires, or a grounded wire, or high resistance connections can cause the charging circuit to operate improperly.
 - A. If the lead from the field winding to the "F" terminal of the regulator (marked "B" in the wiring diagram Fig. 30) should become grounded. Battery will be charged excessively.
 - B. If a high resistance should develop at the "BAT" terminals and the wires connected to the "BAT" terminal at regulator. Ammeter will show an excessively high rate of charge, causing battery to use an abnormal amount of water.
 - C. A short circuit between leads from the stator winding to the rectifier (wires marked "C" and "D", Fig. 30) or from these becoming grounded. Ammeter will show a discharge and an undercharged battery would result.
2. It is important that wiring be checked visually for damage due to corrosion, frayed insulation and loose connections.
3. Additional checks are covered in the following sections.

TESTING FOR SHORTED OR OPEN RECTIFIER DIODES, OR A SHORTED SUPPRESSION CONDENSER (CAPACITOR)

1. Before checking diodes for shorts or opens, disconnect battery leads, the large nylon connector, the condenser lead, the four diode leads from the harness and remove both fuses.
2. To check the condenser for capacity and shorts, refer to page 11 and 12, Fig. 14. Also top of page 14 for proper grounding.
3. Condenser capacity is approximately .2 microfarads.

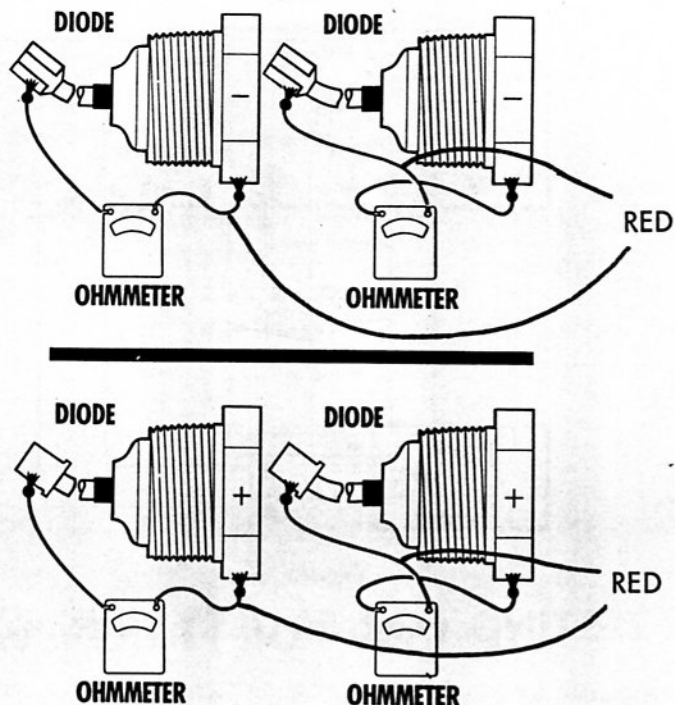

Figure 31

TESTING DIODES

1. To test diodes for shorts and opens, each diode must be checked twice.
2. These two checks are accomplished by reversing the polarity such as the negative and positive.
3. This test can be made on your Merc-O-Tronic Analyzer. (Black lead-, small Red lead-)
4. By placing selector switch on position No. 3 Coil Continuity (See page 8, paragraph 1, 2, and 3) and by reading the lower red figure on meter scale No. 3.
5. Connect small test leads as shown in Fig. 31 between the center post and the base.
6. A zero reading in both tests as outlined above indicates the diode is shorted.
7. A normal diode will show a high reading in one direction and a low reading in the opposite direction.
8. An infinite (Very High) reading in both tests indicates the diode being tested is open.
9. Before replacing a diode, coat the diode threads with silicone grease or light engine oil, and then tighten to 150-180 inch-pounds of torque.

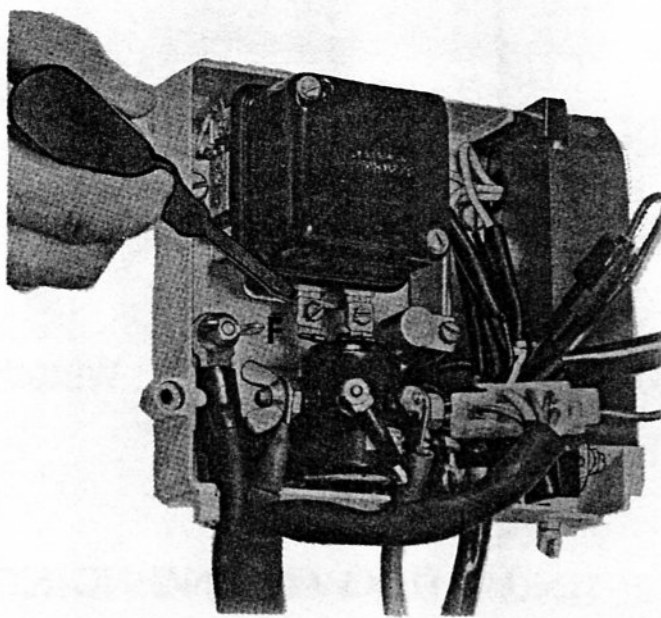

Figure 32

TESTING OUTPUT OF AC GENERATOR OR UNI-CHARGER

1. The AC generator can be checked for output by shorting between the regulator "F" terminal and ground with a screwdriver. (Fig. 32).
 - A. Operate engine slightly above idle speed, (1500 RPM) and note the reading on the ammeter.
 - B. All accessories must be turned off when this check is made.
 - C. If output is increased (note ammeter reading) the AC generator, uni-charger, or rectifier is not at fault.
 - D. The trouble is probably due to an improper regulator voltage setting or a defective regulator.
 - E. In this case, proceed to the section entitled "Checking Regulator Voltage Setting."
2. If no output is obtained, the AC generator or uni-charger is defective.
3. Both the field winding and the stator winding should be checked with the ohmmeter on the Merc-O-Tronic Analyzer scale No. 2 or 3 as required.

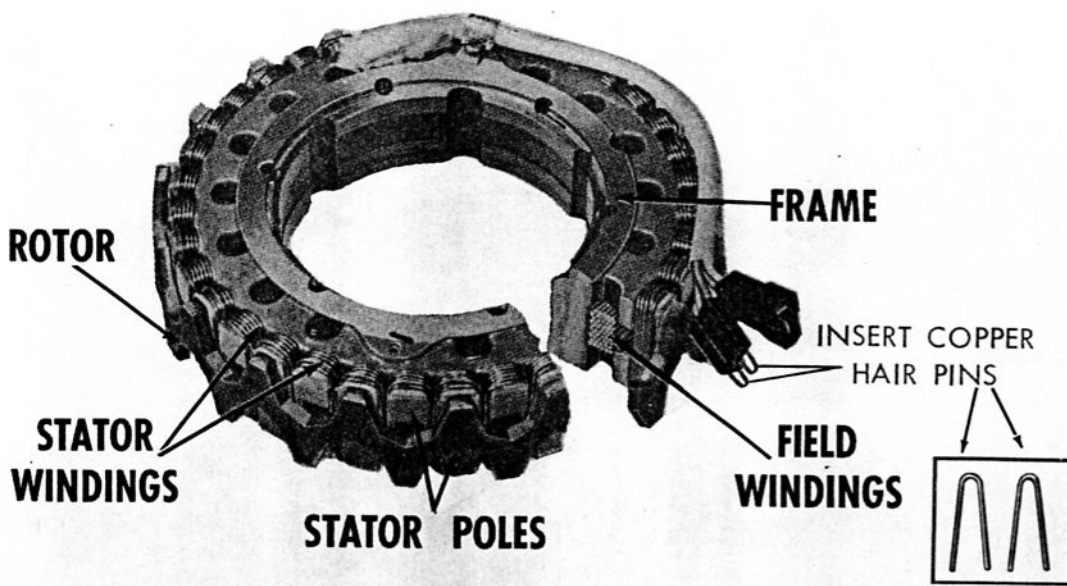

Figure 33

TESTING FIELD WINDINGS

1. To test the field winding, separate the field winding connector (the one with the red and blue leads) from the wiring harness.
2. Take two pieces of bare copper wire (20 GA) about 2'' long and shape into hairpins. See illustration above.
3. Place in each female connector making contact with each terminal, see Fig. 33.
4. This will allow you to make field winding test without any difficulty.
 - A. Turn selector switch to position No. 2 do not clip small test leads together.
 - B. Adjust meter knob scale No. 2 so meter pointer will line up on red set line on right side of meter.
5. After zeroing in meter pointer attach one small lead to either hairpin connector and the other small lead to the lamination or stator.
6. The reading should be infinite if the field winding is not grounded.
7. When testing for shorted or open field windings leave the two copper hairpins in position as in Fig. 33.
8. Connect the other small test lead to the other hairpin and leave selector switch on position No. 2, read scale No. 2.
9. The readings should be 1.2 - 3.2 ohms or (1.9 - 2.2 ohms at 80^oF).
10. A lower reading indicates a shorted winding.
11. An infinite reading indicates winding is open.
12. In either case the field winding is defective.

TESTING THE STATOR WINDING

1. Adjust analyzer for the following tests procedure.
 - A. Place selector switch on position No. 2.
 - B. Adjust meter, knob for scale No. 2 until meter pointer lines up on set position on right side of Scale No. 2.
2. Separate the Stator Winding Connector (the one with the two yellow leads) from the harness.
3. Take one small test lead and attach to one of the copper contacts in the harness connector.
4. The other small test lead attach to the core.
5. Read meter scale No. 2, reading should be infinite.
6. Any meter pointer movement indicates the winding is partially grounded.
7. If meter pointer moves to the left, this indicates winding is grounded or defective.
8. If meter pointer does not move at all remove small test lead connected to the core and attach to the other copper contact in the harness connector.
9. Leave selector switch on position No. 2.
10. Read meter scale No. 2 (which is the low resistance value scale).
11. Winding should show a reading of minimum .2 - maximum .3.
12. If meter pointer moves only a part of the way, this indicates a poor connection or a partial open.
13. If meter pointer does not move at all or there is an infinite reading this indicates winding is open.
14. In either case the winding is defective and stator assembly should be replaced, or defect located and repaired.
15. Internally shorted stator windings are difficult to test due to the very low resistance of the windings.
16. If all the generator and rectifier checks are satisfactory but the output is low, an internally shorted stator winding (which in some cases do not show up on the meter) could be the cause.

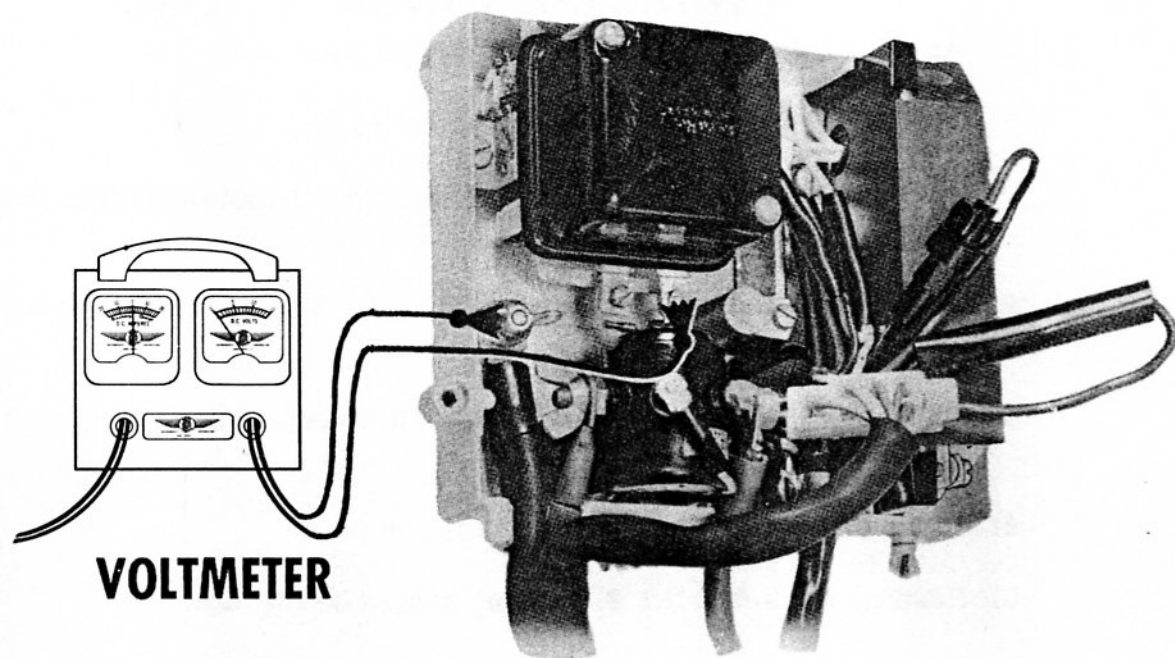

Figure 35

INCORRECT REGULATOR VOLTAGE SETTING

CAUTION: Do not short across any of the terminals in the junction box.

1. To check the voltage setting reconnect all connections and then connect the positive voltmeter lead to the regulator "BAT" terminal and the negative lead to ground. (Fig. 35).
2. Turn on the switch but do not start the engine.
3. The voltmeter should read battery voltage.
4. A zero reading indicates an open in the circuit between the regulator and the battery. If green "on light" lights up on the dash the open circuit would be between the key switch and regulator. If ignition coil had current the open would be from the red wire to the field to regulator.
5. If the voltmeter reads battery voltage, operate the engine at 1500 rpm for 20 minutes with the cover on the regulator and all accessories turned off to bring the regulator to operating temperature.
For accurate RPM readings use the Merc-O-Tronic Electronic Service Tachometer.
6. Turn off the ignition switch to stop the engine.
7. Restart the engine, operate it at 1500 rpm and note the voltage setting.
8. The dash ammeter must show a charge of not over 10 amperes at the time the voltage setting is read.

A fully charged battery must be used to adjust regulator.

9. If the voltage setting is 15 volts or above, the charge rate may continue above 10 amperes after the 20-minute warm-up period.
10. In this case the voltage setting needs to be reduced.
11. If the voltage setting is below 15 volts but the charge rate remains above 10 amperes, continue to charge the battery until the charge rate drops to below 10 amperes before reading the voltage setting.
12. The voltage setting should be 14.4 to 15.0 volts at ambient temperature. Ambient temperature is the temperature of the air surrounding the regulator 1/4 inch from the cover.

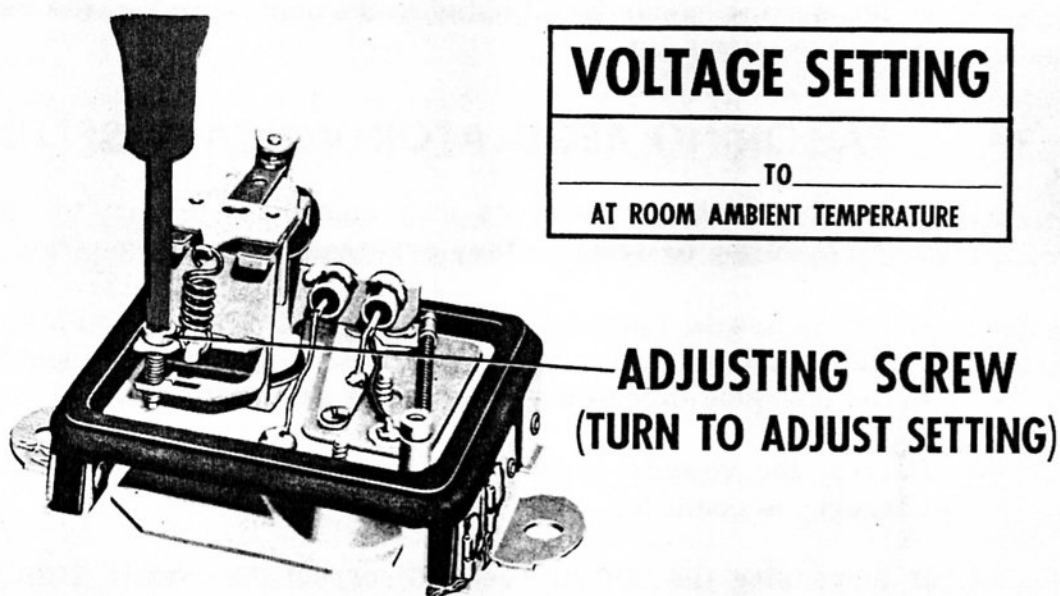

Figure 36

ADJUSTING VOLTAGE SETTING

1. To adjust the voltage setting, remove the regulator cover and turn the voltage adjusting screw located on the back of the voltage unit. (Fig. 36).
2. This should be done after the 20-minute warm-up period with the engine operating at 1500 rpm.
3. Turning the screw clockwise will raise the setting, and counter-clockwise will lower the setting.

CAUTION: Always make final setting by turning the screw clockwise. This insures that the springholder will be against the head of the screw. Therefore, turn the screw counterclockwise farther than necessary to make the adjustment. Then turn the screw clockwise to make final setting. Replace the regulator cover.

4. After making the setting, turn off the switch and stop the engine.
5. Restart the engine and operate it at 1500 rpm and note voltage setting.
6. Readjust if necessary.
7. Always stop and restart the engine before reading the final voltage setting.
8. Always make final voltage checks with the regulator cover in place.
9. If the setting cannot be adjusted to the desired value, the regulator is defective internally.

TAILORING REGULATOR VOLTAGE SETTING

1. Unusual operating conditions may make it necessary to "tailor" the voltage setting to avoid battery overcharge or undercharge.
2. If the engine is operated consistently at low speeds with accessories turned on, the battery may become discharged even though the units in the charging circuit are functioning satisfactorily.
3. Raising the voltage setting to a value within the specified limits may correct the condition.
4. If increasing the setting does not correct the trouble, it is likely that the accessory load is too great for the generator output at that particular speed.
5. Similarly, consistent operation at moderate or high speeds with light electrical loads may result in excessive battery water usage denoting battery overcharge.
6. This is especially true under hot weather conditions.
7. A lower voltage setting in this case may be required.
8. If changing the setting by .3 volt does not correct the condition, the setting should be changed an additional .3 volt and then a check made for an improved battery condition.

TRANSISTOR

REGULATOR

VOLTMETER

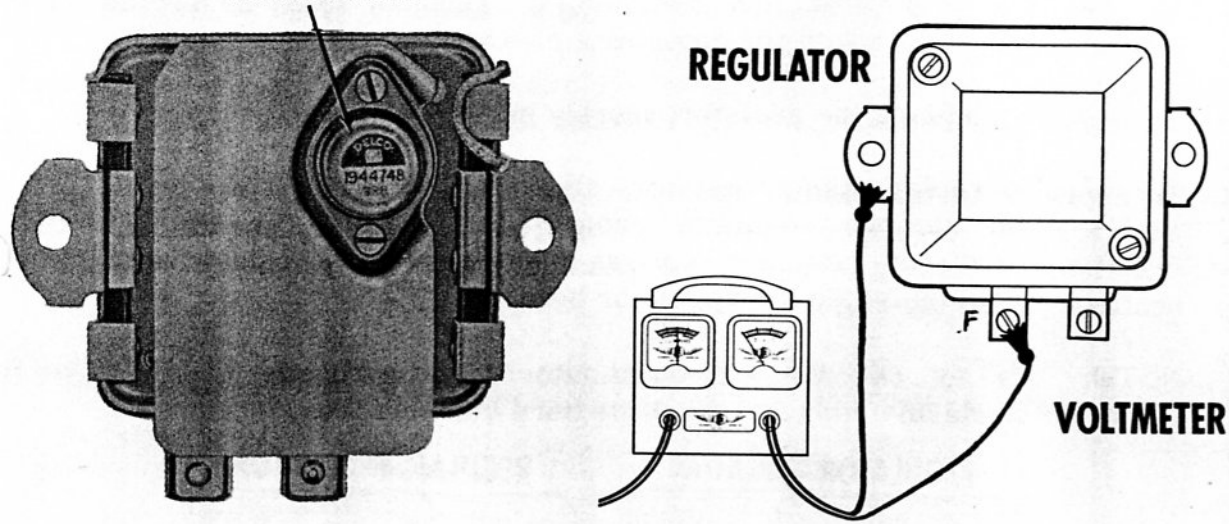

Figure 37

INTERNAL REGULATOR CHECKS

The components inside the regulator may be checked with the regulator connected in the circuit as shown in Figure 30.

TRANSISTOR

1. To check the transistor, connect a voltmeter from the regulator "F" terminal to ground (Fig. 37).
2. Close the switch without starting the engine, and note the voltmeter reading.
3. A reading of approximately 1 to 2 volts is normal.
4. If the reading is zero volts, the transistor is shorted.
5. An intermittent short between the leads from the field winding to the regulator (marked "A" and "B" on the wiring diagram, Fig. 30), an open regulator field discharge diode, an open suppression diode, or excessive heat can cause the transistor to become shorted.
6. If the reading is approximately 8 to 9 volts the transistor is burned open.
7. An open transistor can result from a direct short between the field winding leads ("A" and "B" in the wiring diagram, Fig. 30), or from interchanging the leads at the regulator "F" and "BAT" terminals.

8. If the reading is battery voltage, both the transistor and regulator resistor are burned open.
9. The transistor and resistor, if damaged, must be replaced before proceeding with the remaining checks.
10. To replace the resistor, merely unsolder the connections.
11. To replace the transistor, disconnect battery and all regulator leads and remove regulator from junction box. Then remove the two transistor attaching screws and unsolder the two transistor connections inside the regulator box.

NOTE: Do not reconnect the regulator leads until after the field discharge diode and suppression diode have been checked.

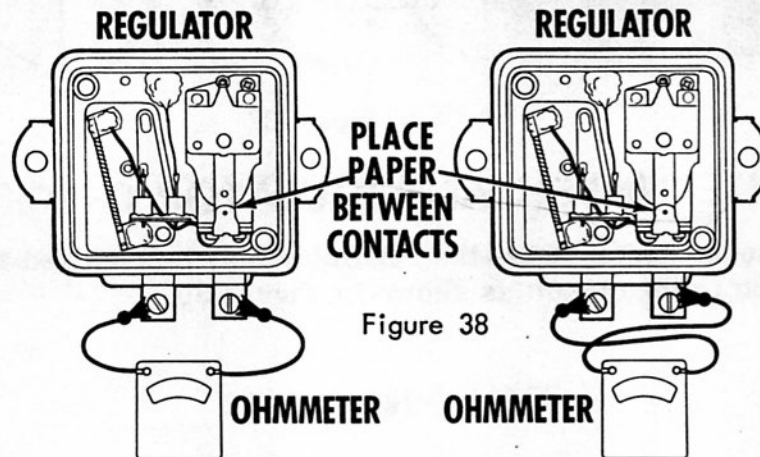

Figure 38

CHECKING FIELD DISCHARGE DIODE

FIELD DISCHARGE DIODE

The following tests can be made on the Merc-O-Tonic analyzer selector switch position No. 3 Meter Scale No. 3.

1. To check the field discharge diode, place a small piece of clean white paper between the voltage contacts to insulate them. See Fig. 38.
2. Connect small leads from analyzer to the "F" and "BAT" (Fig. 38) terminals. (Note the readings).
3. Reverse the lead connections to the "F" and "BAT" (Fig. 38) terminals. (Note the readings).
4. If either reading is very high (infinite), the regulator field discharge diode is open.
5. If both readings are approximately zero, the regulator field discharge diode is shorted.
6. Remove the small piece of paper.
7. To replace the diode, merely unsolder the connections.

CAUTION: Excessive heat will damage diode.

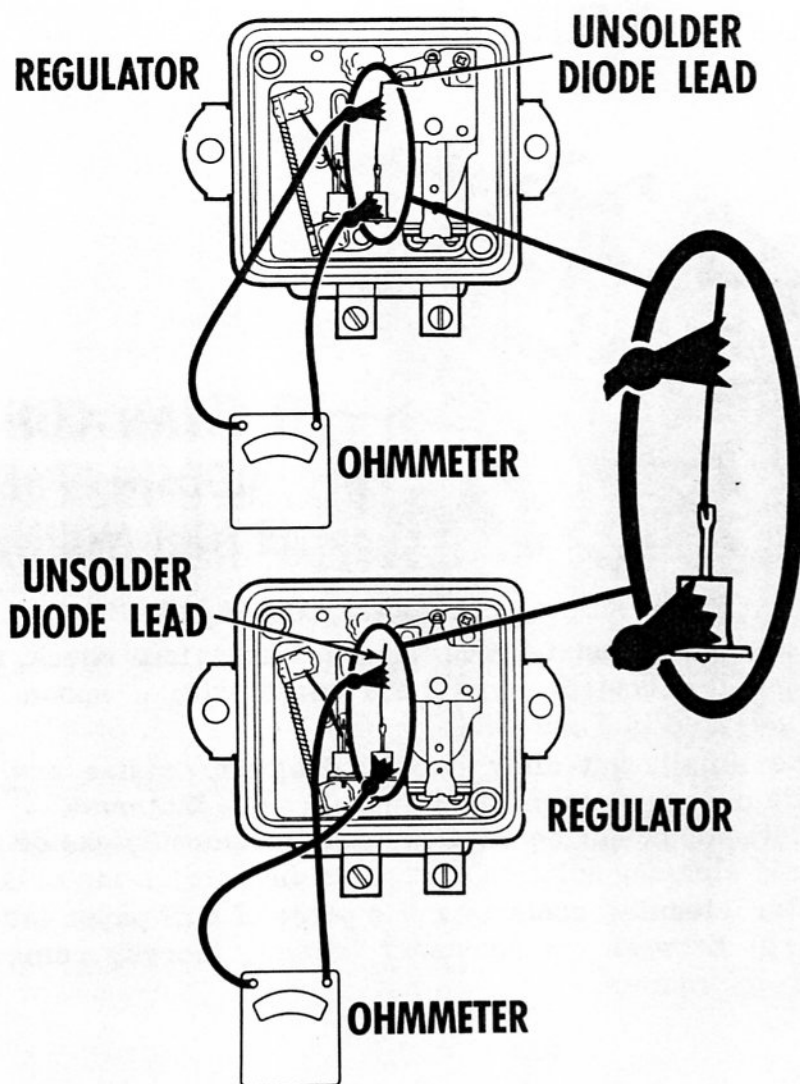

CHECKING SUPPRESSION DIODE

Figure 39

SUPPRESSION DIODE

1. To check the suppression diode, unsolder its lead from the regulator base and connect the small leads from analyzer from the diode lead to the diode case (Fig. 39). Use Test Position No. 3.
2. Then reverse the ohmmeter lead connections.
3. If both readings are very high (infinite), the diode is open.
4. If both readings are zero, the diode is shorted.
5. To replace the diode, merely unsolder the connections.

CAUTION: Excessive heat will damage diode.

RIFFLER FILE

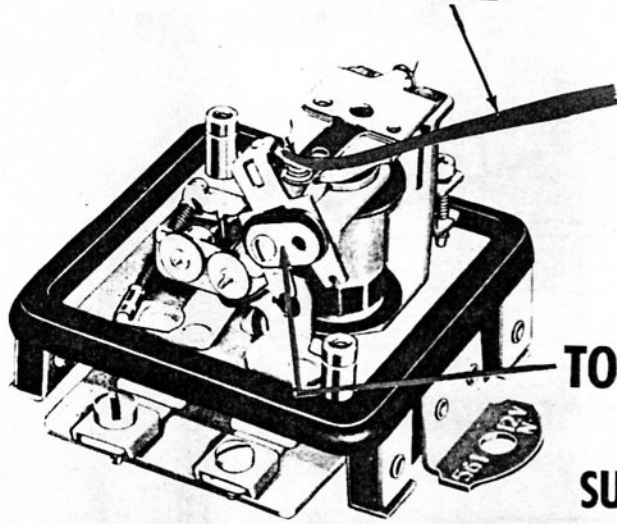

Figure 40

TO CLEAN CONTACT POINTS (LOOSEN UPPER CONTACT SUPPORT MOUNTING SCREWS)

CLEANING CONTACTS

1. If an open transistor was found in the previous check, the large voltage regulator contact must be cleaned with a spoon or riffer file as illustrated in Figure 40.
2. The small soft-alloy contact does not oxidize and must be cleaned with crocus cloth or other fine abrasive material.
3. Contacts should be washed with trichlorethylene or some other non-toxic cleaning solution to remove any foreign material.
4. After cleaning contacts run a piece of stiff paper (such as a business card) between contact under tension, thereby removing any film or foreign matter.

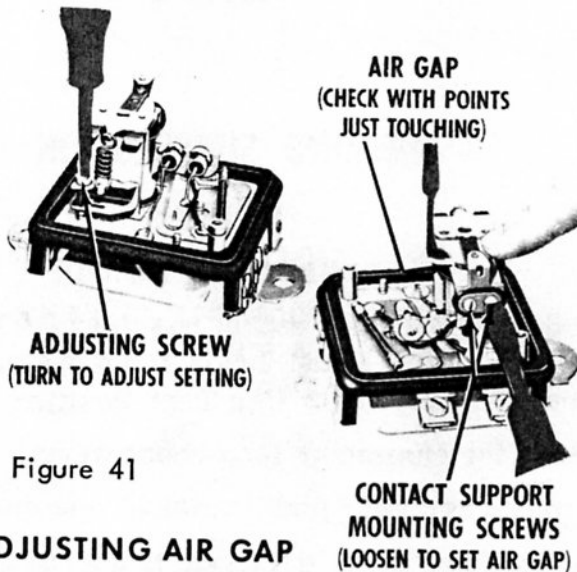

Figure 41

ADJUSTING AIR GAP

CONTACT SUPPORT
MOUNTING SCREWS
(LOOSEN TO SET AIR GAP)

1. After cleaning the contacts, set the air gap to .070 inch as shown in Figure 41.
2. Push the armature (not the flat spring) down against a gauge.
3. Adjust the upper contact support so the contacts are aligned squarely and just touch when the support screws are tightened.

MANUFACTURERS SPECIFICATIONS

FOR COIL AND CONDENSER

TESTS ON MERC-O-TRONIC

MAGNETO ANALYZER.

TESTS MADE MUST

BE WITHIN THE SPECIFIED

TOLERANCES OR THE PART

SHOULD BE REPLACED AS IT

IS DEFECTIVE AND NOT UP

TO MANUFACTURER'S

SPECIFICATIONS.

SERVICE HINTS

Ignition Failures

- I. Engine Misfires at Idle or High Speed, Presuming Carburetion and Fuel Are OK, Check for: -
- Incorrect spark plug gap
 - Defective or loose spark plugs
 - Spark plugs of incorrect heat range
 - Spark plug gap set incorrectly
 - Sticking or weak breaker arm spring
 - Incorrect breaker point gap
 - Breaker points not synchronized
 - Breaker points not properly adjusted
 - Loose wire in primary circuit
 - Defective distributor rotor
 - Corroded or pitted breaker points
 - Cracked distributor cap
 - Leaking or broken high tension wires
 - Weak armature magnets
 - Worn cam lobes on distributor or magneto shaft
 - Worn distributor or magneto shaft bushings
 - Defective coil or condenser
 - Defective ignition switch
 - Spark timing out-of-adjustment
- II. Engine Backfires
- Through Exhaust, Check for: -
- Cracked spark plug porcelain
 - Carbon path in distributor cap
 - Crossed spark plug wires
 - Air leak at intake deflector
 - Improper timing
- III. Engine Pre-Ignition, Check for Ignition Causes: -
- Spark advanced too far
 - Incorrect type spark plugs
 - Burned spark plug electrodes
 - Incorrect breaker setting
- IV. Starter Motor - If There Is Excessive Current Draw, Check for: -
- Broken, jammed starter drive
 - Dirty, gummed armature
 - Shorted armature
 - Grounded armature or field
 - Resistance from engine
 - Misaligned starting motor
 - Worn armature shaft bearings
 - Misaligned armature shaft
 - Loose field pole pieces

SERVICE HINTS - Cont'd.

IV. Starter Motor (Cont'd)

If Starter Fails to Operate, Check for: -

- Poor battery ground
- Jammed drive
- Broken teeth on flywheel
- Direct ground in switch
- Solenoid dead or shorted
- Burned contact points in switch
- Improper seating brushes
- High mica between commutator segments
- Shorted armature
- Shorted field or brushes

V. Distributor System Failures - With Ignition System as Guide, If There Is Breaker Point Oxidation, Check for: -

- High battery voltage
- Resistor of incorrect capacity
- High resistance in condenser circuit
- Incorrect type ignition coil

With Ignition System as Guide, If There Is Breaker Point Oxidation, Check for: -

- Extremely high voltage
- Moisture formation
- Excessive heat from engine

VI. Electrical Failures - If Frequent Battery Charge Is Necessary, Check for: -

- Corroded battery terminals
- Alternator grounded or shorted
- Worn out, inefficient battery
- Rectifier defective
- Short circuit in charging circuit
- Excessive use of electrical units
- Short circuit in ignition switch

WICO MAGNETO COILS SPECIFICATIONS

Coil No.	Type	Operating Amperage	Secondary Continuity
IFAX-103	F. Right Hand	1.40	
IKBX-103	EK-Right Hand	1.60	35-55
IXDX-103	OC-Right Hand	1.35	
IFAX-104	F. Left Hand	1.40	
IKBX-104	EK-Left Hand	1.60	35-55
IXDX-104	OC-Left Hand	1.35	
18-X123C	FGB-Left Hand	1.50	
18-X123D	FGB-Right Hand	1.50	
X1910	AH-All Models	1.50	45-65
X2005	AP	1.40	
X2156	FW	1.50	30-50
X2631	OC-Right Hand-HD	1.40	40-60
X2632	OC-Left Hand-HD	1.40	40-60
X2766	A & C All Models	2.10	35-55
X2770	AP	1.50	50-70
X2770B	APH	1.90	50-70
X2937	FW	2.40	
X3040	FW	2.80	
X3040A, B, C, D	FW	1.50	50-70
X3430	EM	1.40	
X3682	J & JEM	1.40	45-65
X4366B	R.E.M.	1.30	
X4658	FW	1.90	40-60
X4658B	FW	1.55	40-60
X4791	FW	2.30	50-70
X4943	FW	1.50	35-55
X5345	FW	1.50	40-60
X5460C	FW	1.50	30-50
X5700 & 5700C	XH	1.70	40-60
X5700B		1.70	40-60
X5953	FW	2.20	40-60
X6111	FW	1.60	35-55
*X6664	XH-2D Use *X8964	2.30	
X6718	FW	1.80	40-60
X6762	XH-1-Xh-1295 B & C only	2.50	40-60
X6872B	XB-Short Lead to GRD	1.40	45-65
X6877B	XB	2.10	
X6933	FW	1.45	
X6936	XHD4 and XVD6	1.75	
X6985	FW	1.50	35-55
X7120	FW	1.40	30-50
X7233	FW	1.80	40-60
X7325	FW	1.70	40-60
X7345	FW	1.70	35-55
X7438	FW	1.80	40-60
X7453	FW Use X4658B	1.55	

WICO MAGNETO COILS SPECIFICATIONS (Cont'd)

Coil No.	Type	Operating Amperage	Secondary Continuity
X7467	FW	1.80	30-50
X7500	FW	2.10	30-50
X7536	FW	1.90	38-58
X7560	○ FW	1.70	
X7585	○ XHD-1	2.30	
X7680	FW	1.80	
X7700	○ RES	1.90	
X7744	○ XH	1.70	
X7886B	XH1	2.20	30-50
X7895B	XHS-2D	2.60	45-65
X8545	XH1	2.00	40-60
X8668	FW	1.70	40-60
X8786	FW	1.80	30-50
X8795	FW	1.80	30-50
X8798	XB	2.20	45-65
X8877	FW	2.00	
*X8964	○ XH-2D Use X11600	2.30	
X9055	FW	2.10	35-55
X9144	FW	1.60	50-70
X9295	B (Center Core Only)	2.30	35-55
X9295	B (On Stator Both Cores)	2.10	35-55
X9533	FW	2.20	30-50
X9692	FW	2.30	35-55
X9697	○ FW	2.30	
X9767	FW	1.80	35-55
X9965	FW	1.8	40-55
X11049	FW	1.85	30-50
X11180	FW	1.80	40-55
X11205		2.0	40-55
X11260	FW	1.8	40-55
X11352		2.00	40-60
X11406		2.10	40-60
X11477		2.00	40-60
X11563		0.75	40-60
*X11600		1.90	40-60
X11654		2.1	40-55
X11856		1.8	40-55
X12254		1.8	45-60
X12302		2.2	40-55
X12325		1.8	40-55

*Ground one lead.

Wico (Green) XH-1 (Replaced by X5700)

WICO ELECTRIC COILS

Coils No.	Operating Amperage	Primary Resistance Test on Model 88 only	Secondary Continuity
X30089B	1.1	1.1 - 1.3	40-55

WICO MAGNETO CONDENSER SPECIFICATIONS

Condenser	Magneto	Capacity Reading in Microfarads	Condenser	Magneto	Capacity Reading in Microfarads
12-X235	EK, OC, Old Style	.10-.15	X8680	XHS-1, XHS-2	.16-.20
X1413	A, C, J, JEM	.16-.20	X8807	FW	.30-.34
X2186	FW	.16-.20	X8959	FW	.16-.20
X2394	FG	.20-.22	X9100	FW	.26-.30
X2413	AP-Left Hand	.16-.20	X9106	FW	.18-.23
X2414	AP	.20-.24	X9182	FW	.26-.30
X2664	FG	.16-.20	X9263	B	.30-.34
X2981	FW	.16-.20	X9293	XVS	.26-.30
X3222	EM	.16-.20	X9327	FW	.26-.30
X3517	AP-Right Hand	.16-.20	X9451	FW	.16-.20
X4034	FW	.16-.20	X9686	XHS-1	.18-.20
X4215	FW	.16-.20	X10400	REM	.18-.23
X5321	FW	.16-.20	X11000	FW	.16-.23
X5342	FW	.30-.34	X11181	FW	.16-.20
X5463	FW	.16-.20	X11337		.26-.30
X5614	XH, XV	.16-.20	X11362		.26-.30
X5800	FW	.16-.20	X11397		.16-.20
X5833	FW	.16-.20	X11672		.16-.20
X5847	FW	.16-.20	X12174		.16-.20
X5999	A, C, J, JEM	.16-.20	X12264		.26-.30
X6028	FW	.16-.20	X12293		.18-.22
X6029	EM	.16-.20	X12513		.16-.20
X6030	FW	.16-.20	X30028	DB	.18-.23
X6091	FW	.16-.20			
X6138	APH	.30-.34			
EX6367	Edison RM-2, 4, 6	.16-.20			
EX6369	Edison RM-1, 2	.16-.20			
X6494	EK, OC	.16-.20			
X6874	XB	.30-.34			
X6916	XHD, XVD	.30-.34			
X6937		.16-.20			
X6977	XB	.30-.34			
EX6980	RM	.16-.20			
X7228	FW	.16-.20			
X7331	FW	.10-.15			
X7372	FW	.30-.34			
X7461	FW	.10-.15			
X7529	FW	.16-.20			
X7720	XHS	.16-.20			

R. E. PHELON MAGNETO COILS SPECIFICATIONS

Coil No.	Operating Amperage	Continuity Min. Max.	Coil No.	Operating Amperage	Continuity Min. Max.
FG-114 (taped)	2.5	40 - 60	FG-2180	2.8	40 - 60
FG-307 Series (taped)	2.5	40 - 60	FG-2331	2.8	40 - 60
FG-420 Series	2.8	40 - 60	FG-2444		
FG-463 Series (taped) B	2.8	40 - 60	FG-2446	2.8	40 - 60
FG-470 Series (taped) B	2.8	40 - 60	FG-2454	2.5	40 - 60
*FG-492 Series B	2.5	40 - 60	FG-2546	2.5	40 - 60
FG-608	2.5	45 - 65	FG-2641	2.8	40 - 60
FG-678	2.8	40 - 60	FG-2723	2.8	40 - 60
FG-1054	2.5	45 - 65	FG-2732	2.8	40 - 60
FG-1070	2.5	40 - 60	FG-2914	2.8	40 - 60
FG-1309	2.8	40 - 60	FG-2976	2.8	50 - 70
FG-1573 Series C	2.8	40 - 60	FG-3082	2.8	50 - 70
**FG-1618	2.8	40 - 60	FG-3294	2.8	40 - 60
FG-1641	2.2	50 - 70	FG-3375	2.8	35 - 55
FG-1835	2.5	45 - 65	FG-3437	1.0	55 - 75
FG-2145	2.8	40 - 60	FG-3681	1.8	55 - 75
			FG-3689	2.5	40 - 60
			FG-3755	2.5	40 - 60
			FG-4055	2.8	50 - 70
			FG-4081	2.8	40 - 60
			FG-4128	2.5	40 - 55

Coils above are molded unless listed "(taped)".

*FG-492 Coil - Ground out one secondary terminal while testing other.

**FG-1618 Coil - Connect the core ends (common ground) during tests.

R. E. PHELON CONDENSER SPECIFICATIONS

Part No.	Capacity Mfd.	Part No.	Capacity Mfd.
FG-159	.15-.19	FG-2138	.12-.16
FG-216 Series	.15-.19	FG-2176	.15-.19
FG-410 Series	.12-.16	FG-2448	.12-.16
FG-458 Series	.12-.16	FG-2642	.12-.16
FG-471 Series	.12-.16	FG-2727	.18-.22
FG-549	.12-.16	FG-2733	.15-.19
FG-607	.15-.19	FG-2780	.12-.16
FG-1019	.12-.16	FG-2993	.18-.22
FG-1057	.16-.20	FG-3044	.24-.28
FG-1205	.34-.38	FG-3478	.18-.22
FG-1316	.12-.16	FG-3693	.15-.19
FG-1338	.15-.19	FG-4016	.18-
FG-1355	.12-.16	FG-4082	
FG-1770	.14-.18		
FG-1807	.22-.27		
FG-1928	.22-.27		
FG-2111	.12-.16		

FAIRBANKS-MORSE COIL SPECIFICATIONS

Coil No.	Type	Operating Amperage	Secondary Continuity Min. Max.
A2477 . . .	RV1	1.55**	
A2477 . . .	RV1	2.40*	
A2477A . .	FMJE1	1.60	
A2477C	1.80	35 - 55
B2477	RV4-6, DRV	2.10*	
B2477A . . .	FMJHE2	1.55	
BX2477 . . .	FMXC1B70	1.70	
C2477	FM-FMK-FMH-FMO-FMOK-FMOH	1.55	
C2477A . . .	FMJFE2-FMJJE4-FMJG4	1.55	
C2477AX . .	FMJE4	1.55	
D2477	RS1-FM1B	1.55	
DX2477C	1.25	40 - 60
E2477	FMJ4A-FMJ4B	1.70	40 - 60
EX2477C	1.40	40 - 60
F2477	FMT4B (Battery Ignition with Bridge Laminations)	1.40	
FX2477	1.90	50 - 60
G2477	FMJ4A-FMJ4B	1.55	
H2477	FMJV4-FMJVE4	1.70	40 - 60
H2477C	1.90	45 - 65
HX2477	1.90	50 - 60
J2477	FMO1	1.55	
JX2477	2.00	40 - 60
K2477	FMO-FMOH	1.55	
L2477	FMJ1	1.80	35 - 55
L2477C	1.80	35 - 55
L2477X . . .	FMJ1A	1.60	
LX2477C	1.50	40 - 60
M2477	FMJ1A2	1.55	
P2477	1.55	40 - 60
P2477C	1.60	40 - 60
Q2477C . . .	Double Secondary Leads	1.70	50 - 70
Q2477C	1.70	50 - 70
QS2477C	1.65	45 - 65
QT2477C	1.70	45 - 65
QY2477C	2.30	45 - 60
R2477C	1.70	40 - 60
RS2477C	1.70	40 - 60
S2477C	1.90	45 - 65
T2477	FMXV4B70	1.80	40 - 60
T2477C	1.80	35 - 55
U2477	1.70	50 - 60
U2477C	1.60	40 - 60
A2480	R2 (Wound Armature)	1.80	
B2480A . . .	R (Wound Armature)	1.80	

* Bakelite Housing Coil ** Tape Wound

FAIRBANKS-MORSE
CONDENSER CAPACITIES SPECIFICATIONS

Part No.	Capacity Reading in Microfarads	
	Min.	Max.
MX2433	.28	.35
BX2433	.16	.19
AX-M-R2433	.18	.23
SXY2433	.28	.33
LV2433	.38	.43
K2433	.16	.24
S2433	.28	.32
M2433	.18	.22
AX2433	.17	.23
M2433	.17	.23
R2433	.17	.23
EX2433	.17	.23
JX2433	.28	.36
S2433	.28	.36
X2433	.28	.36
Y2433	.16	.19
GX2433	.28	.36
CX2433	.28	.36
DX2433	.28	.36
FX2433	.28	.36
BX2433	.16	.19
HX2433 Fead Through	.37	.43

BENDIX SCINTILLA
COIL SPECIFICATIONS

Coil No.	Type	Maximum Amperage
4936	PN	2.30
4998	GN	1.95
5179	MN	2.10
2-306	VAG	1.95
2-751	SF9-SB9	1.90
2-752	VAG	2.10
10-1518	SGA	2.10
10-2160	C-CR-CG	1.60
10-2160	Bendix "C" Series	1.55
10-2160W	Bendix "C" Series	1.35
10-2160Y	Bendix "C" Series	1.60
10-5294	SCA	2.30
10-6710	MN4-6	2.00
10-8548	PC Series	1.75
10-9247	12 Volt Battery Coil	1.10
10-9267	6 Volt Battery Coil	1.45
10-9606	SG Series	1.75
10-13165	SF4-SB5-SB6	1.70
10-13623Y	SF14-1	1.80
10-13624	SCD-1	1.90
10-13625Z	SB14-1	1.80
10-13760	Bendix "C" Series	1.60
10-14856	MN	2.10
10-14857	VMN Series	2.10
10-15829 Y, W, V	PA Series	1.80
10-15829U	PA Series	1.90
10-16144	12 Volt Battery Coil-H Comp.	1.10
10-17288 and Y	CBR Series	1.60
10-17970Y	LA Series	1.00
10-54007	H Series	1.90
10-57460	LA Series	1.35
10-77308	H1 Series	1.60
10-77379	H1 Series	1.60
10-77334	H2 Series (Single SPK)	1.80
10-79157	K Series	2.30
10-81703	VAG Series	2.10
10-82215	K Series	1.60
10-82241	K Series	2.30
10-82259	K Series	2.30
*10-84356Y	K Series	1.80
10-86641	K Series	1.60

*Test with coil on stator plate and insulate between contact points.

BENDIX SCINTILLA
COIL SPECIFICATIONS (Cont'd)

K Series Coil No.	Operating Amperage		Maximum Secondary Continuity
	On Stator Plate	Off Stator Plate	
10-3822	2.0	2.3	60
10-38222Y	2.0	2.3	60
10-50715	1.8	2.1	60
10-70100	1.8	2.1	50
10-70128	1.8	2.1	50
10-70132	1.8	2.1	50
10-70169	1.8	2.1	50
10-70161	2.1	2.4	60
10-70199	2.1	2.4	60
10-94097	1.8		45
10-111287	1.8		58

BENDIX SCINTILLA CONDENSER SPECIFICATIONS

Condenser No.	Type	Minimum Capacity
10-13373Y	VMN Series	.18
10-17453	C Series	.29
10-12049	PA, PB Fixed Spark	.17
10-15061	PA, PB Variable Spark	.17
10-81927	PA6/2F	.17
10-12049	PC	.17
2-755Y	VAG Series	.17
10-82104	H Series	.15
10-55555	H1-21	.14
10-38350W	K Series	.15
10-54916	K Series	.15
10-54954	K Series	.15
10-70141	K Series	.17
10-70162	K Series	.15
10-76413	K Series	.35
10-79125	K Series	.15
10-79168Y	K Series	.27
10-79188	K Series	.15
10-82104	K Series	.13
10-82207	K Series	.29
10-82238	K Series	.15
10-86610	K Series	.15
10-23186	OA1	.16
10-23186	OA2 (10-20650-2)	.16
10-56546	OA2 (10-32420-1)	.14
10-17453	LA	.29
10-85252	LA	.60
10-81958	LAR	.7
10-81956	LAR	1.5
10-85256	LAR	1.5
10-4341Z	S-1	.15
10-20654	S-1	.20
10-20654	DS-1	.20
10-37626	S4R(L)N-32	.18
10-37626	S6R(L)N-32	.18
10-3159Z	BA Battery Timer	.29
10-53229	SW6LN-12 Battery Timer	.22
10-15061	WN Battery Timer	.17
10-81650	Automag	.18
10-102513	LC	.78
10-102513	DLC L.H.	.78
10-102514	DLC R.H.	.78
10-88603		.23

KIEKHAEFER-MERCURY OUTBOARD COIL SPECIFICATIONS

Kiekhæfer Part No.	Manufacturer	Mfgr. No.	Mounted Operating Amperage	Secondary Continuity Min. Max.
30-204	Scintilla	10-38222Y	2.30	40 - 60
399-125	Scintilla	10-70132	2.10	30 - 50
399-756	Scintilla	10-70100	2.10	30 - 50
398-716	Phelon	F-608	2.50	40 - 65
398-173	Phelon	F-1835	2.50	40 - 65
397-361	Fairbanks-Morse	H-2477	2.00	40 - 60
		E-2477C		
397-361	Fairbanks-Morse	T-2477	2.00	40 - 60
397-430	Fairbanks-Morse	QY-2477C	2.00	45 - 60
396-648	Eisemann	27894	1.60	40 - 60
395-679	Wico	X-2156	1.50	30 - 50
394-1128	Kiekhæfer		*1.80	55 - 65
26433	Kiekhæfer	Delco-Remy	0.90	55 - 65
**399-1246	Scintilla	10-111280	1.50	30 - 42

*Off Plate

KIEKHAEFER-MERCURY OUTBOARD CONDENSER TEST SPECIFICATIONS

Kiekhæfer Part No.	Manufacturer	Mfgr. No.	Capacity Reading in Microfarads
399-759	Scintilla	10-70141	.17-.21
**399-123	Scintilla	10-82238	.15-.21
398-713	Phelon	FG-607	.15-.19
398-176	Phelon	FG-1807	.22-.27
398-693	Phelon	FG-1770	.14-.18
396-650	Eisemann	24235	.19-.23
395-684	Wico	X-2186	.16-.20
397-741	Fairbanks-Morse	"S"	.28-.32
397-359	Fairbanks-Morse	M 2433	.18-.22
397-874	Fairbanks-Morse	KX 2433	.28-.35
393-1283	Delco-Remy		.18-.23
394-1130	Kiekhæfer	394-1130	.28-.35

**Also used on Kiekhæfer and Distin Chain Saw Model DA 211 both right and left sides.

NOTE: See Magneto Manufacturers Specifications for "Off the Plate" Tests.

JOHNSON MOTOR MAGNETO COILS
SPECIFICATIONS

Coil No.	Type	Operating Amperage	Secondary Continuity	
			Min.	Max.
72-110	Old A25	2.30	..	
72-582	A25 to 50 - AZ35 to 45	2.40	..	30 - 60
72-641	P30, P35, P40, P45, TR40	2.00	..	45 - 65
72-669	K35, K40, K45	2.40	..	30 - 60
72-749	F1036	1.90	..	
72-792	A25 to 50 - AZ35 to 45	2.10	..	30 - 60
72-808	S45-550-SR50-SR55	2.20	..	
72-813	V45 & Up 4 Cyl. 2 Coils	2.40	..	30 - 60
72-851	XR55-OK55-60-P50	0.60	..	65 - 80
72-852	SV & 1/4 - 50 & Up, All Models	1.00	..	65 - 80
72-875	A50 & Up - K50 & Up	1.70	..	50 - 65
72-947	F70-F75-OA55-OA60-OB	2.00	..	30 - 60
72-1005	300-36 Twin	2.60	..	30 - 60
72-1017	Iron Horse	2.40	..	
72-1018	Iron Horse (All Models)	1.27	..	30 - 60
72-1045	LT37-LS37-DT37-DS37	2.40	..	
72-1072	LT. LD. & AT-37 & Up	2.31	..	30 - 60
275-370		1.80	..	50 - 65
275-540		1.50	..	65 - 80
276-039		1.80	..	50 - 65
375-102	SD-10-1940	1.00	..	50 - 65
375-189	TS, TD, HS, HD, MS, & MD, & Later	1.30	..	34 - 46
580-040		1.60	..	30 - 40
580-084		1.60	..	34 - 46
580-118		1.60	..	30 - 40
580-197		1.40	..	42 - 52
580-243	50 HP.	1.70	..	40 - 55

JOHNSON MAGNETO CONDENSER
SPECIFICATIONS

Condenser No.	Capacity Reading in Microfarads	Condenser No.	Capacity Reading in Microfarads
72-864	.27-.33	171-471	.18-.25
72-873	.20-.24	201-484	.16-.24
170-002 - Use 172-470	.27-.36	201-753	.16-.24
170-067 - Use 171-449	.09-.125	300-153	.15-.205
171-311 - Use 171-471	.18-.25	510-173	.18-.22
171-448	.09-.125	580-243	.37-.41
171-449	.09-.125		
171-470	.27-.36		

EVINRUDE MAGNETO COILS
SPECIFICATIONS

EVINRUDE MAGNETO CONDENSER
SPECIFICATIONS

Coil No.	Operating Amperage		Secondary Continuity		Condenser No.	Capacity Microfarads	
	Min.	Max.	Min.	Max.		Min.	Max.
72-851	.60	...	65	- 80	72-864	.27	- .33
72-852	1.00	...	65	- 80	72-873	.20	- .24
72-875	1.70	...	50	- 65	170-002 - Use 171-470..	.27	- .36
191-181	1.50	...	30	- 55	170-067 - Use 171-449..	.09	- .125
192-648	1.90	...	30	- 55	171-311 - Use 171-471..	.18	- .25
194-168	1.50	...	30	- 50	171-448	.09	- .125
195-911	1.20	...	30	- 55	171-449	.09	- .125
275-019	1.90	...	30	- 55	171-470	.27	- .36
275-370	1.50	...	50	- 65	171-471	.18	- .25
275-540	1.50	...	65	- 80	201-484	.16	- .24
276-039	1.50	...	50	- 65	201-753	.16	- .24
375-102	1.00	...	50	- 65	300-153	.15	- .205
375-189	1.30	...	34	- 46	501-173	.18	- .22
580-040	1.60	...	30	- 40	580-256	.37	- .41
580-084	1.60	...	34	- 46			
580-118	1.60	...	30	- 40			
580-197	1.40	...	42	- 52			
580-243	1.70	...	40	- 55			

PIONEER CHAIN SAW MODEL 400

Coil No.	Operating Amperage	Primary Resistance on Model 88 Only		Secondary Continuity
		Min.	Max.	
.470685	1.4	.5	- .7	40-55
		Capacity Microfarads		
		Condenser No.	Min. Max.	
		426528	.18-.22	

PIONEER CHAIN SAW MODEL 600

Coil No.	Operating Amperage	Secondary Continuity
X11180	1.80	35-55
Condenser No.	Type	Capacity Microfarads Min. Max.
X11181	FW	.16 - .20

LAWN BOY COIL
SPECIFICATIONS

LAWN BOY CONDENSER
SPECIFICATIONS

Coil No.	Operating Amperage	Continuity Min. Max.	Condenser No.	Capacity Microfarads
580-116	1.60	30 - 40	510-173	.13 - .17
580-184	1.60	30 - 40	677299	.13 - .17

BRIGGS & STRATTON MAGNETO COILS

SPECIFICATIONS

Coil No.	Type	Operating Amperage	Secondary Continuity	
			Min.	Max.
29656	A-B-H-K-Y-ZZ-BP-BRG-ZZP-ZZR6- AP-AR6	.50	45	65
29657	F-FB-FC-FE-FG-FH-FI-FJI-FM-L-M- MB-PB-Q-R-S-T-W	.70	30	55
29671	WI-WM-WMB-WMI-U-N-NP-NPR-NR . .	1.50	10	50
290880 . . .	9-14-23 Standard	1.15	36	56
291617 . . .	W, I, N, 5S, 6S & 8	1.70	30	50
292029 . . .	9-14-23 Radio Shielded	1.25		
292184 . . .	N 7 8 Radio Shielded	1.90	10	50
293431 . . .	Double Secondary	1.0	43	63
295845	1.70	30	50
295915 . . .	Armature - Magneto - Primary Resistance, Min .225, Max .325 (Note test same as Double Secondary Coil) (See page 21. illustration, Fig. 26.	2.50	40	50
296834 . . .	141 - 143	1.70	30	50

BRIGGS & STRATTON CONDENSER

SPECIFICATIONS

Condenser No.	Capacity Microfarads
2986116 - .26
29136916 - .26
294-62816 - .26

McCULLOCH CORPORATION
MARINE PRODUCTS DIVISION
OUTBOARD MOTOR SPECIFICATIONS
(FORMERLY SCOTT-ATWATER MFG. CO.)

Year	Engine Model No.	Kind	HP	Stator Assy. No.	Make Mfg.	Coil No.	Operat. Amp.	Secondary Continuity Min. Max.	Condenser No.	Capacity Microfarads
1949	491	SA	4	X-5880-F	Wico	X-5460F	1.50	30 - 50	X-5463-F	.16 - .20
1949	4911	F	4		Phelon	F-307	2.50	40 - 60	FG-216	.15 - .19
1949	4921	C	4	X-5880-F	Wico	X-5460F	1.50	30 - 50	X-5463-F	.16 - .20
1949	493-	SA	7.5	X-6339F	Wico	X-5460F	1.50	30 - 50	X-5463F	.16 - .20
1949	4913	F	7.5	X-6339F	Wico	X-5460F	1.50	30 - 50	X-5463F	.16 - .20
1949	4923	C	7.5	X-6339F	Wico	X-5460F	1.50	30 - 50	X-5463F	.16 - .20
1949	497	SA	5.0	X-7010	Wico	X-5460F	1.50	30 - 50	X-5463F	.16 - .20
1949	4917	F	5.0	X-7010	Wico	X-5460F	1.50	30 - 50	X-5463F	.16 - .20
1949	4927	C	4917	X-7010	Wico	X-5460F	1.50	30 - 50	X-5463F	.16 - .20
1950	5010	F	3.6	FG-571	Phelon	FG-470	2.8	40 - 60	FG-471	.12 - .16
1950	501	S-A	4.0	X-5880	Wico	X-7120	1.40	30 - 50	X-5463	.16 - .20
1950	5011	F	4.0	FG-571	Phelon	FG-470	2.80	40 - 60	FG-471	.12 - .16
1950	5021	C	4.0	X-7325	Wico	X-7325	1.70	40 - 60	X-7331	.10 - .15
1950	503	S-A	7.5	X-7010	Wico	X-7120	1.40	30 - 50	X-5463	.16 - .20
1950	5013	F	7.5	FG-614	Phelon	FG-470	2.80	40 - 60	FG-471	.12 - .16
1950	5023	C	7.5	FG-614	Phelon	FG-470	2.80	40 - 60	FG-471	.12 - .16
1950	507	SA	5.0	X-7010	Wico	X-7120	1.40	30 - 50	X-5463	.16 - .20
1950	5017A	F	5.0	FG-580	Phelon	FG-470	2.80	40 - 60	FG-471	.12 - .16
1950	5027	C	5.0	X-7329	Wico	X-7325	1.70	40 - 60	X-7331	.10 - .15

McCULLOCH CORP. OUTBOARD MOTOR SPECIFICATIONS (Cont'd)

Year	Engine Model No.	Kind	HP	Stator Assy. No.	Make Mfg.	Coil No.	Operat. Amp.	Secondary Continuity Min. Max.	Condenser No.	Capacity Microfarads
1950	509-1	16 hp	G. H.		Wico	X-7345	1.70	35 - 55	X-5463	.16 - .20
1951	510	SA	3.6	X-5880	Wico	X-7120	1.40	30 - 50	X-5463	.16 - .20
1951	510P	SA	3.6	FG-571A	Phelon	FG-470B	2.80	40 - 60	FG-471B	.12 - .16
1951	5110	F	3.6	FG-571A	Phelon	FG-470B	2.80	40 - 60	FG-471B	.12 - .16
1951	511	SA	4.0	X-7554	Wico	X-7500	2.10	30 - 50	X-5463	.16 - .20
1951	513	SA	7.5	X-7561	Wico	X-7500	2.10	30 - 50	X-5463	.16 - .20
1951	5113	F	7.5	FG-614A	Phelon	FG-470B	2.80	40 - 60	FG-471B	.12 - .16
1951	5123	C	7.5	FG-614A	Phelon	FG-470B	2.80	40 - 60	FG-471B	.12 - .16
1951	517	SA	5	X-7561	Wico	X-7500	2.10	30 - 50	X-5463	.16 - .20
1951	5117	F	5	FG-580A	Phelon	FG-470B	2.80	40 - 60	FG-471B	.12 - .16
1951	5127	C	5	FG-580A	Phelon	FG-470B	2.80	40 - 60	FG-471B	.12 - .16
1951	518	SA	10	X-7561	Wico	X-7500	2.10	30 - 50	X-5463	.16 - .20
1951	518-2	SA	10	X-7561	Wico	X-7500	2.10	30 - 50	X-5463	.16 - .20
1951	5118	F	10	X-7561	Wico	X-7500	2.10	30 - 50	X-5463	.16 - .20
1951	5128	C	10	X-7561	Wico	X-7500	2.10	30 - 50	X-5463	.16 - .20
1951	511-0			X-5880	Wico	X-7120	1.40	30 - 50	X-5463	.16 - .20
1951	513-0			X-7010	Wico	X-7120	1.40	30 - 50	X-5463	.16 - .20
1951	517-0			X-7010	Wico	X-7120	1.40	30 - 50	X-5463	.16 - .20

McCULLOCH CORP. OUTBOARD MOTOR SPECIFICATIONS (Cont'd)

Year	Engine Model No.	Kind	HP	Stator Assy. No.	Make Mfg.	Coil No.	Operat. Amp.	Secondary Continuity Min. Max.	Condenser No.	Capacity Microfarads
1952	0025			X-7554	Wico	X-7500	2.10	30 - 50	X-5463	.16 - .20
1952	1025	F	3.6	FG-571A	Phelon	FG-470B	2.80	40 - 60	FG-471B	.12 - .16
1952	1325	F	7.5	FG-614A	Phelon	FG-470B	2.80	40 - 60	FG-471B	.12 - .16
1952	1325B	F	7.5	FG-614A	Phelon	FG-470B	2.80	40 - 60	FG-471B	.12 - .16
1952	2325	C	7.5	FG-614A	Phelon	FG-470B	2.80	40 - 60	FG-471B	.12 - .16
1952	2325B	C	7.5	FG-614A	Phelon	FG-470B	2.80	40 - 60	FG-471B	.12 - .16
1952	3325	SA	7.5	FG-614A	Phelon	FG-470B	2.80	40 - 60	FG-471B	.12 - .16
1952	1725	F	5.0	FG-580A	Phelon	FG-470B	2.80	40 - 60	FG-471B	.12 - .16
1952	2725	C	5.0	FG-580A	Phelon	FG-470B	2.80	40 - 60	FG-471B	.12 - .16
1952	3725	SA	5.0	X-7561	Wico	X-7500	2.10	30 - 50	X-5463	.16 - .20
1952	1825	F	10	X-7561	Wico	X-7500	2.10	30 - 50	X-5463	.16 - .20
1952	2825	C	10	X-7561	Wico	X-7500	2.10	30 - 50	X-5463	.16 - .20
1952	3825	SA	10	X-7561	Wico	X-7500	2.10	30 - 50	X-5463	.16 - .20
1952	3825-2	SA	10	X-7561	Wico	X-7500	2.10	30 - 50	X-5463	.16 - .20
1952	3925	SA	16	X-8726	Wico	X-7345	1.70	35 - 55	X-5463	.16 - .20
1952	3925-B	SA	16	X-8726	Wico	X-7345	1.70	35 - 55	X-5463	.16 - .20
1952	3925-2	SA	16	X-8726	Wico	X-7345	1.70	35 - 55	X-5463	.16 - .20
1953	1035		3.6	FG-571-A	Phelon	FG-470B	2.80	40 - 60	FG-471B	.12 - .16
1953	3035		3.6	FG-571-A	Phelon	FG-470B	2.80	40 - 60	FG-471B	.12 - .16
1953	1335		7.5	FG-1629	Phelon	FG-1573C	2.80	40 - 60	FG-471B	.12 - .16
1953	2335		7.5	FG-1629	Phelon	FG-1573C	2.80	40 - 60	FG-471B	.12 - .16
1953	3335		7.5	FG-1629	Phelon	FG-1573C	2.80	40 - 60	FG-471B	.12 - .16
1953	1735		5.0	X-7561	Wico	X-7500	2.10	30 - 50	X-5463	.16 - .20

McCULLOCH CORP. OUTBOARD MOTOR SPECIFICATIONS (Cont'd)

Year	Engine Model No.	Kind	HP	Stator Assy. No.	Make Mfg.	Coil No.	Operat. Amp.	Secondary Continuity Min. Max.	Condenser No.	Capacity Microfarads
1953	2735		5.0	X-7561	Wico	X-7500	2.10	30 - 50	X-5463	.16 - .20
1953	3735		5.0	X-7561	Wico	X-7500	2.10	30 - 50	X-5463	.16 - .20
1953	1835		10		Wico	X-7500	2.10	30 - 50 ₆	X-5463	.16 - .20
1953	3935		16	X-8726	Wico	X-7345	1.70	35 - 55	X-5463	.16 - .20
1953	3935-2		16	X-8726	Wico	X-7345	1.70	35 - 55	X-5463	.16 - .20
1954	1745		5		Wico	X-7467	1.80	30 - 50	X-9182	.26 - .30
1954	2745		5		Wico	X-7467	1.80	30 - 50	X-9182	.26 - .30
1954	3745-		5		Wico	X-7467	1.80	30 - 50	X-9182	.26 - .30
1954	3345		7.5	FG-1301	Phelon	FG-4708	2.80	40 - 60	FG-4718	.12 - .16
1954	1845		10		Wico	X-7467	1.80	30 - 50	X-9182	.26 - .30
1954	2845		10		Wico	X-7467	1.80	30 - 50	X-9182	.26 - .30
1954	3845		10		Wico	X-7467	1.80	30 - 50	X-9182	.26 - .30
1954	1945		16	X-8726	Wico	X-7345	1.70	35 - 55	X-9182	.26 - .30
1954	2945		16	X-8726	Wico	X-7345	1.70	35 - 55	X-9182	.26 - .30
1954	3945		16	X-8726	Wico	X-7345	1.70	35 - 55	X-9182	.26 - .30
1954	3945-2		16	X-8726	Wico	X-7345	1.70	35 - 55	X-9182	.26 - .30

McCULLOCH CORP. OUTBOARD MOTOR SPECIFICATIONS (Cont'd)

Year	Engine Model No.	Kind	HP	Stator Assy. No.	Make Mfg.	Coil No.	Operat. Amp.	Secondary Continuity Min. Max.	Condenser No.	Capacity Microfarads
1955	1055		3.6	FG-1632	Phelon	FG-1573G	2.80	40 - 60	FG-471B	.12 - .16
1955	3055			FG-1632	Phelon	FG-1573G	2.80	40 - 60	FG-471B	.12 - .16
1955	1755		5.7		Wico	X-7467	1.80	30 - 50	X-9182	.26 - .30
1955	1355		7.5	FG-1629	Phelon	FG-1573C	2.80	40 - 60	FG-471B	.12 - .16
1955	2355			FG-1629	Phelon	FG-1573C	2.80	40 - 60	FG-471B	.12 - .16
1955	1855		10		Wico	X-7467	1.80	30 - 50	X-9182	.26 - .30
1955	2855				Wico	X-7467	1.80	30 - 50	X-9182	.26 - .30
1955	1955		16	X-8726	Wico	X-7345	1.70	35 - 55	X-9182	.26 - .30
1955	3655	Std. P. S.		FG-2118	Phelon	FG-2331	2.80	40 - 60	FG-2111	.12 - .16
1956	1665	F	33	FG-2552	Phelon	FG-2546	2.50	40 - 60	FG-2111	.12 - .16
1956	1665-3	F(EL)	33	FG-2552	Phelon	FG-2546	2.50	40 - 60	FG-2111	.12 - .16
1956	2665	C	33	FG-2552	Phelon	FG-2546	2.50	40 - 60	FG-2111	.12 - .16
1956	2665-3	C(EL)	33	FG-2552	Phelon	FG-2546	2.50	40 - 60	FG-2111	.12 - .16
1956	3665	SA	33	FG-2552	Phelon	FG-2546	2.50	40 - 60	FG-2111	.12 - .16

McCULLOCH CORP. OUTBOARD MOTOR SPECIFICATIONS (Cont'd)

Year	Engine Model No.	Kind	HP	Stator Assy. No.	Make Mfg.	Coil No.	Operat. Amp	Secondary Continuity Min. Max.	Condenser No.	Capacity Microfarads
1956	3665-2	SA(LC)	33	FG-2552	Phelon	FG-2546	2.50	40 - 60	FG-2111	.12 - .16
1956	3665-3	SA(EL)	33	FG-2552	Phelon	FG-2546	2.50	40 - 60	FG-2111	.12 - .16
1956	3665-4	SA(EL)	33	FG-2552	Phelon	FG-2546	2.50	40 - 60	FG-2111	.12 - .16
1956	4665	G	33	FG-2552	Phelon	FG-2546	2.50	40 - 60	FG-2111	.12 - .16
1956	4665-3	G(EL)	33	FG-2552	Phelon	FG-2546	2.50	40 - 60	FG-2111	.12 - .16
1957	1075	F.	3.6	FG-1632	Phelon	FG-1573	2.80	40 - 60	FG-471B	.12 - .16
1957	1775	F.	5		Wico	X-7467	1.80	30 - 50	X-9182	.26 - .30
1957	1875	F.	10		Wico	X-7467	1.80	30 - 50	X-9182	.26 - .30
1957	1975	F.	16	X-8726	Wico	X-7345	1.70	35 - 55	X-5463	.16 - .20
1957	1675	F.	35	FG-2550	Phelon	FG-2546	2.50	40 - 60	FG-2111	.12 - .16
1957	1316	F.	35E.	FG-2550	Phelon	FG-2546	2.50	40 - 60	FG-2111	.12 - .16
1957	3075	S.A.	3.6	FG-1632	Phelon	FG-1573	2.80	40 - 60	FG-471B	.12 - .16
1957	3775	SA	5		Wico	X-7467	1.80	30 - 50	X-9182	.26 - .30
1957	3375	S.A.	7.5	FG-1629	Phelon	FG-1573C	2.80	40 - 60	FG-471B	.12 - .16
1957	3875	S.A.	10		Wico	X-7467	1.80	30 - 50	X-9182	.26 - .30
1957	3975	S.A.	16	X-8726	Wico	X-7345	1.70	35 - 55	X-5463	.16 - .20
1957	339	S.A.	16E.	X-9763	Wico	X-7345	1.70	35 - 55	X-5463	.16 - .20
1957	3675	S.A.	40	FG-2903	Phelon	FG-2546	2.50	40 - 60	FG-2727	.18 - .22
1957	336	S.A.	40E.	FG-2902	Phelon	FG-2723	2.80	40 - 60	FG-2727	.18 - .22
1957	536	S.A.	Royal	FG-2902	Phelon	FG-2723	2.80	40 - 60	FG-2727	.18 - .22
1957	4075	Hia.	3.6	FG-1632	Phelon	FG-1573	2.80	40 - 60	FG-471B	.12 - .16
1957	4775	Hia.	5		Wico	X-7467	1.80	30 - 50	X-9182	.26 - .30
1957	4375	Hia.	7.5	FG-1629	Phelon	FG-1573C	2.80	40 - 60	FG-471B	.12 - .16
1957	4975	Hia.	16	X-8726	Wico	X-7345	1.70	40 - 60	X-5463	.16 - .20
1957	4675	Hia.	38	FG-2550	Phelon	FG-2546	2.80	40 - 60	FG-2111	.12 - .16

McCULLOCH CORP. OUTBOARD MOTOR SPECIFICATIONS (Cont'd)

Year	Eng. No.	Make	HP	Stator Assy. No.		Mfg. Make	Coil No.		Oper. Amp.	Secondary Continuity Min. Max.	Generator Coil No.		Condenser No.		Capacity Micro-farads
				Mfg.	Scott		Mfg.	Scott			Mfg.	Scott	Mfg.	Scott	
1958	135	Scott Manual	22	X11383	135-101	Wico	X11352	3685-113	2.2	37 - 57		X11362	3685-115	.26 - .30	
1958	335	Scott	22	X11345	335-101	Wico	X11352	3685-113	2.2	37 - 57	X11353	X11362	3685-115	.26 - .30	
1958	332	Scott	60		332-101	Phelon	FG3437	332-113	1.0	55 - 75		FG3044	332-115	.24 - .28	
1958															

McCULLOCH CORP. OUTBOARD MOTOR SPECIFICATIONS (Cont'd)

Year	Eng. No.	Make	HP	Stator Assy. No.		Mfg. Make	Coil Number		Oper. Amp.	Secondary Continuity Min. Max.	Gen. Coil No.		Condenser No.		Capacity Micro-farads
				Mfg.	Scott		Mfg.	Scott			Mfg.	Scott	Mfg.	Scott	
1958	3085	Scott	3.6	X11445	3085-101	Wico	X11477	3885-113	2.00	40 60		X11397	3885-115	.16 - .20	
1958	3785	Scott	5	X9066	3845-101	Wico	X7467	3845-113	1.80	30 50		X9182	3745-115	.26 - .30	
1958	3785	Scott	5	X5118	3785-101	Wico	X11477	3885-113	2.00	40 60		X11397	3885-115	.16 - .20	
1958	3385	Scott	7.5	FG1629	1355-101	Phel	FG1573C	1355-134	2.8	40 60		FG471B	5010-115	.12 - .16	
1958	3385	Scott	7.5	X11391	3885-101	Wico	X11477	3885-113	2.00	40 60		X11397	3885-115	.16 - .20	
1958	3885	Scott	10	X11391	3885-101	Wico	X11477	3885-113	2.00	40 60		X11397	3885-115	.16 - .20	
1958	3985	Scott	16	X8726	3925-101	Wico	X7345	509-113	1.70	35 55		X9182	3745-115	.26 - .30	
1958	135	Scott	22	X11383	135-101	Wico	X11352	3685-113	2.00	40 60		X11362	3685-115	.26 - .30	
1958	335	Scott	22E	X11345	335-101	Wico	X11352	3685-113	2.00	40 60		X11362	3685-115	.26 - .30	
1958	3685	Scott	40	FG2852	3675-101	Phel	FG2546	3665-134	2.5	40 60		FG2727	3675-115	.18 - .22	
1958	3685	Scott	40	X11537	3685-101	Wico	X11352	3685-113	2.00	40 60		X11362	3685-115	.26 - .30	
1958	3685	Scott	40E	FG2687	336-101	Phel	FG2546	3665-134	2.5	40 60		FG2727	3675-115	.18 - .22	
1958	3685	Scott	40E	FG3232	1336-101	Phel	FG3375	3665-134	2.8	35 55		FG2727	3675-115	.18 - .22	
1958	3685	Scott	40E	FG3475	1436-101	Phel	FG3375	3665-134	2.8	35 55		FG3478	636-115	.18 - .22	
1958	1536	Scott	40	FG3232B	1536-101	Phel	FG3375	3665-134	2.8	35 55		FG2727	3675-115	.18 - .22	
R.S.															
1958	332	Scott	60		332-101	Phel	FG3437	332-113	1.0	55 75		FG3044	332-115	.24 - .28	
1959	130A	Scott	3.6	X11445	3085-101	Wico	X11477	3885-113	2.00	40 60		X11397	3885-115	.16 - .20	

McCULLOCH CORP. OUTBOARD MOTOR SPECIFICATIONS (Cont'd)

Year	Eng. No.	Make	HP	Stator Assy. No.		Mfg. Make	Coil Number		Oper. Amp.	Secondary Continuity Min. Max.	Gen. Coil No.		Condenser No.		Capacity Micro-farads
				Mfg.	Scott		Mfg.	Scott			Mfg.	Scott	Mfg.	Scott	
1959	137A	Scott	5	X5118	3785-101	Wico	X11477	3885-113	2.00	40		X11397	3885-115	.16 - .20	
	137A	Scott	5	X9066	3845-101	Wico	X7467	3845-113	1.80	30		X9182	3745-115	.26 - .30	
	137A	Scott	5	FG3712	137-101	Phel	FG3689	138-134	2.5	40		FG3693	138-115	.15 - .19	
1959	133A	Scott	7.5	FG3714	138-101	Phel	FG3689	138-134	2.5	40		FG3693	138-115	.15 - .19	
1959	138A	Scott	10	X9066	3845-101	Wico	X7467	3845-113	1.80	30		X9182	3745-115	.26 - .30	
	138A	Scott	10	FG3714	138-101	Phel	FG3689	138-134	2.5	40		FG3693	138-115	.15 - .19	
1959	135A	Scott	25	X11976B	735-101	Wico	X11352	3685-113	2.00	40		X11362	3685-115	.26 - .30	
	135A	Scott	25	FG3800	535-101	Phel	FG3755	436-134	2.5	40		FG3478	1436-115	.18 - .22	
	135A	Scott	25	FG3800	535-101	McCulloch	736-232	736-232	1.6	43		FG3478	1436-115	.18 - .22	
	335A	Scott	25E	FG3799	635-101	Phel	FG3755	436-134	2.5	40	FG3809	535-134	1436-115	.18 - .22	
	335A	Scott	25E	FG3799	635-101	McCulloch	736-232	736-232	1.6	43	FG3810	635-134	1436-115	.18 - .22	
1959	335A	Scott	25E	W11983B	435-101	Wico	X11352	3685-113	2.00	40	X11353	335-113	3685-115	.26 - .30	
1959	136A	Scott	40	X11987B	136-101	Wico	X11352	3685-113	2.00	40		X11362	3685-115	.26 - .30	
	136A	Scott	40	FG3770	236-101	Phel	FG3755	436-134	2.5	40		FG3478	1436-115	.18 - .22	
	136A	Scott	40	FG3770	236-101	McCulloch	736-232	736-232	1.6	43		FG3478	1436-115	.18 - .22	
	336A	Scott	40E	FG3624	436-101	Phel	FG3375	3665-134	2.8	35	FG3476	1336-134	1436-115	.18 - .22	
1959	336A	Scott	40E	FG3752	836-101	Phel	FG3755	436-134	2.5	40	FG3477	1436-134	1436-115	.18 - .22	
1959	336A	Scott	40E	FG3752	836-101	McCulloch	736-232	736-232	1.6	43	FG3760	136-134	1436-115	.18 - .22	
1959	336A	Scott	40E	12076	936-101	Wico	X11352	3685-113	2.00	40	X11710	435-113	3685-115	.26 - .30	
	332A	Scott	60		332-101	Phel	FG3437	332-113	1.0	55		FG3044	332-115	.24 - .28	
							FG3681	432-113	1.8	55					

McCULLOCH CORP. OUTBOARD MOTOR SPECIFICATIONS (Cont'd.)

Year	Eng. No.	Make	HP	Stator Assy. No.		Mfg. Make	Coil No.		Oper. Amp.	Secondary Continuity Min.-Max.	Gen. Coil No.		Condenser No.		Capacity Micro-farads
				Mfg.	Scott		Mfg.	Scott			Mfg.	Scott	Mfg.	Scott	
1960	A3BB	Scott	3.6		130-101	Phelon	FG3689	138-134	2.5	40 - 60		FG3693	138-115	.15-.19	
1960	A3KB	Scott	6.0	134-101	134-101	McCul	134-134	134-134	1.9	30 - 45		X12293	134-115	.18-.22	
1960	A3EB	Scott	7.5	134-101	134-101	McCul	134-134	134-134	1.9	30 - 45		X12293	134-115	.18-.22	
1960	C3EB	Scott	7.5	134-101	134-101	McCul	134-134	134-134	1.9	30 - 45		X12293	134-115	.18-.22	
1960	A3FB	Scott	12		139-101	Phelon	FG4128	139-134	2.5	40 - 60		FG3693	138-115	.15-.19	
1960	A3GB	Scott	25M		735-101	Wico	X11352	3685-113	2.0	40 - 60		X11362	3685-115	.26-.30	
1960	B3GB	Scott	25ML		735-101	Wico	X11352	3685-113	2.0	40 - 60		X11362	3685-115	.26-.30	
1960	C3GB	Scott	25E		735-101	McCul	436B-134	436B-134	1.4	40 - 60		X11362	3685-115	.26-.30	
1960	D3GB	Scott	25EL		735-101	McCul	336B-134 Bottom	336B-134 Bottom	1.4	40 - 60		X11362	3685-115	.26-.30	
1960	A3HB	Scott	40M		136B-101	Wico	X11352	3685-113	2.0	40 - 60		X11362	3685-115	.26-.30	
1960	B3HB	Scott	40ML		136B-101	Wico	X11352	3685-113	2.0	40 - 60		X11362	3685-115	.26-.30	
1960	C3HB	Scott	40E		336B-200	McCul	436B-134 Top	436B-134 Top	1.4	45 - 60		X12264	335B-115	.26-.30	
1960	D3HB	Scott	40EL		336B-200	McCul	436B-134 Bottom	436B-134 Bottom	1.4	45 - 60		X12264	335B-115	.26-.30	
1960	E3HB	Scott	40R		336B-200	McCul	436B-134 Top	436B-134 Top	1.4	45 - 60		X12264	335B-115	.26-.30	
1960	F3HB	Scott	40RL		336B-200	McCul	436B-134 Bottom	436B-134 Bottom	1.4	45 - 60		X12264	335B-115	.26-.30	
1960	C3JB	Scott	60E			McCul	C3JB-232	532-134	1.4	45 - 60			332B-115	.25-.27	
1960	D3JB	Scott	60EL			McCul	C3JB-232	C3JB-232	1.4	45 - 60			332B-115	.25-.27	
1960	C3LB	Scott	60E			McCul	C3JB-232	532-134	1.4	45 - 60			332B-115	.25-.27	
1960	D3LB	Scott	60EL			McCul	C3JB-232	C3JB-232	1.4	45 - 60			332B-115	.25-.27	

Mc CULLOCH CORP. OUTBOARD MOTOR SPECIFICATIONS (Cont'd)

Year	Eng. No.	HP	Coil Number			Oper. Amp.	Prim. Res. Min. Max.	Sec. Cont. Min. Max.	Condenser No.		Capacity Micro-farads
			Make	Mfg.	Scott				Mfg.	Scott	
1961	61300310	3.6	Phelon	FG3689	138-134	2.5	45 - 60	FG3693	138-115	.15-.19	
1961	61300610	6.0	Phelon	FG6001	A3EC-134	2.5	45 - 60	FG4477	A3EC-115	.15-.19	
1961	61300710	7.5	Phelon	FG6001	A3EC-134	2.5	45 - 60	FG4477	A3EC-115	.15-.19	
1961	61301210 61301220	14.1	Phelon	FG4128	139-134	2.5	40 - 55	FG3693	138-115	.15-.19	
1961	61302530 61302540 61302550 61302560	27.7 27.7	McCul McCul	C3HC-134 D3HC-134	(top) C3HC-134 (bottom) D3HC-134	1.4 1.4	45 - 55 45 - 55	X12264 X12264	335B-115 335B-115	.26-.30 .26-.30	
1961	61302510 61302520	27.7	Wico	X11352	3685-113	2.0	45 - 60	X11362	3685-115	.26-.30	
1961	61304031 61304041 61304051 61304061	43.7 43.7	McCul McCul	436B-134 336B-134	(top) 436B-134 (bottom) 336B-134	1.4 1.4	45 - 60 45 - 60	X12264 X12264	335B-115 335B-115	.26-.30 .26-.30	
1961	61304011 61304021	43.7	Wico	X11352	3685-115	2.0	40 - 60	X11362	3685-115	.26-.30	
1961	61306031 61306041	60.0	McCul	C3JB-134	C3JB-134	1.4	45 - 55	332B-115	332B-115	.25-.27	
1961	61307031 61307071 61307041 61307081	75.2	McCul	C3JB-134	C3JB-134	1.4	45 - 55	332B-115	332B-115	.25-.27	

McCULLOCH CORP. OUTBOARD MOTOR SPECIFICATIONS (Cont'd)

Year	Eng. No.	HP	Coil Number			Oper. Amp.	Prim. Res. Min. Max.	Sec. Cont. Min. Max.	Condenser No.		Capacity Microfarads
			Make	Mfg.	Scott				Mfg.	Scott	
1962	62300310	3.6	Phelon	FG3689	138-134	2.5		45 - 60	FG3693	138-115	.15-.19
	62300410	3.6	Phelon	FG3689	138-134	2.5		45 - 60	FG3693	138-115	.15-.19
	62300610	6.0	Phelon	FG6001	A3EC-134	2.5		45 - 60	FG4477	A3EC-115	.15-.19
	62300710	7.5	Phelon	FG6001	A3EC-134	2.5		45 - 60	FG4477	A3EC-115	.15-.19
	62300810	7.5	Phelon	FG6001	A3EC-134	2.5		45 - 60	FG4477	A3EC-115	.15-.19
	62301410	14.1	Phelon	FG4128	139-134	2.5		40 - 55	FG3693	138-115	.15-.19
62301420	14.1	Phelon	FG4128	139-134	2.5		40 - 55	FG3693	138-115	.15-.19	
1962	62302610	27.7	Wico	X11352	3685-113	2.0		45 - 60	X11362	3685-115	.26-.30
	62302710	27.7	Wico	X11352	3685-113	2.0		45 - 60	X11362	3685-115	.26-.30
1962	62302730	27.7	McC		C3HC-134	1.4	.55-.85	45 - 60	X12264	335B-115	.26-.30
1962	62302810	27.7	Wico	X11352	3685-113	2.0		45 - 60	X11362	3685-115	.26-.30
	62302820	27.7	Wico	X11352	3685-113	2.0		45 - 60	X11362	3685-115	.26-.30
1962	62302830	27.7	McC		C3HC-134	1.4	.55-.85	45 - 60	X12264	335B-115	.26-.30
	62302840	27.7	McC		C3HC-134	1.4	.55-.85	45 - 60	X12264	335B-115	.26-.30
1962	62304410	43.7	Wico	X11352	3685-113	2.0		45 - 60	X11362	3685-115	.26-.30
	62304420	43.7	Wico	X11352	3685-113	2.0		45 - 60	X11362	3685-115	.26-.30
1962	62304430	43.7			71230A	.95	1.15 - 1.4	60 - 70	X12264	335B-115	.26-.30
	62304440	43.7			71230A	.95	1.15 - 1.4	60 - 70	X12264	335B-115	.26-.30
	62304450	43.7			71230A	.95	1.15 - 1.4	60 - 70	X12264	335B-115	.26-.30
	62304360	43.7			71230A	.95	1.15 - 1.4	60 - 70	X12264	335B-115	.26-.30
	62304350	43.7			71230A	.95	1.15 - 1.4	60 - 70	X12264	335B-115	.26-.30
1962	62307530	75.2			71198	.95	1.1 - 1.3	60 - 70	332B-115	332B-115	.25-.27
	62307540	75.2			71198	.95	1.1 - 1.3	60 - 70	332B-115	332B-115	.25-.27
	62307030	75.2			71198	.95	1.1 - 1.3	60 - 70	332B-115	332B-115	.25-.27
	62307040	75.2			71198	.95	1.1 - 1.3	60 - 70	332B-115	332B-115	.25-.27
	62307630	75.2			71198	.95	1.1 - 1.3	60 - 70	332B-115	332B-115	.25-.27

GALE PRODUCTS - BUCCANEER

Model No.	H.P.	Year	Magneto No.	Coil No.	Operating Amperage	Continuity Min. Max.	Condenser No.	Capacity Microfarads
1B10	1.5	1950	580032	374189	1.9	30 - 45	300153	.15-.205
1B9	3	1950	580077	374189	1.9	30 - 45	300153	.15-.205
3D10B	3	1951-53	580128	580416	1.7	30 - 40	580321	.18-.22
3D11B	3	1953-55	580128	580416	1.7	30 - 40	580321	.18-.22
3D12B	3	1955	580128	580416	1.7	30 - 40	580321	.18-.22
3D13B	3	1956	580128	580416	1.7	30 - 40	580321	.18-.22
3D14B	3	1957	580128	580416	1.7	30 - 40	580321	.18-.22
3D15B	3	1958-59	580128	580416	1.7	30 - 40	580321	.18-.22
2B7	5	1950	590181	375189	1.9	30 - 45	300153	.15-.205
5S10B	5	1951-54	580120	580416	1.7	30 - 40	580321	.18-.22
5D10B	5	1951-54	580120	580416	1.7	30 - 40	580321	.18-.22
5S11B	5	1955	580120	580416	1.7	30 - 40	580321	.18-.22
5D11B	5	1955	580183	580416	1.7	30 - 40	580321	.18-.22
5S12B	5	1956	580120	580416	1.7	30 - 40	580321	.18-.22
5D12B	5	1956	580182	580416	1.7	30 - 40	580321	.18-.22
5D13B	5	1956	580182	580416	1.7	30 - 40	580321	.18-.22
5S13B	5	1957	580120	580416	1.7	30 - 40	580321	.18-.22
5D14B	5	1957	580182	580416	1.7	30 - 40	580321	.18-.22
5S14B	5	1958	580120	580416	1.7	30 - 40	580321	.18-.22
5D16B	5	1959	580120	580416	1.7	30 - 40	580321	.18-.22
2B8	12	1950	580047	580040	1.6	30 - 40	300153	.15-.205
12S10B	12	1951-53	580120	580416	1.7	30 - 40	580321	.18-.22
12D10R	12	1951-53	580120	580416	1.7	30 - 40	580321	.18-.22

GALE PRODUCTS - BUCCANEER (Cont'd)

Model No.	H.P.	Year	Magneto No.	Coil No.	Operating Amperage	Continuity Min.-Max.	Condenser No.	Capacity Microfarads
12D11B	12	1954-55	580153	580416	1.7	30 - 40	580321	.18-.22
12S12B	12	1956	580207	580416	1.7	30 - 40	580321	.18-.22
12D13B	12	1956	580207	580416	1.7	30 - 40	580321	.18-.22
12D14B	12	1956	580207	580416	1.7	30 - 40	580321	.18-.22
12DE13B	12	1956	580207	580416	1.7	30 - 40	580321	.18-.22
12S13B	12	1957	580207	580416	1.7	30 - 40	580321	.18-.22
12S14B	12	1957	580207	580416	1.7	30 - 40	580321	.18-.22
12D15B	12	1957	580207	580416	1.7	30 - 40	580321	.18-.22
12D16B	12	1957	580207	580416	1.7	30 - 40	580321	.18-.22
12DE15B	12	1957	580207	580416	1.7	30 - 40	580321	.18-.22
12S15B	12	1958	580207	580416	1.7	30 - 40	580321	.18-.22
12D17B	12	1958	580254	580416	1.7	30 - 40	580321	.18-.22
12D18B	12	1959	580254	580416	1.7	30 - 40	580321	.18-.22
22D10B	22	1955	580180	580416	1.7	30 - 40	580321	.18-.22
22DE10B	22	1955	580180	580416	1.7	30 - 40	580321	.18-.22
22D12B	22	1955	580180	580416	1.7	30 - 40	580321	.18-.22
22DE12B	22	1955	580180	580416	1.7	30 - 40	580321	.18-.22
22D11B	25	1956	580209	580416	1.7	30 - 40	580321	.18-.22
22DE11B	25	1956	580209	580416	1.7	30 - 40	580321	.18-.22
22D13B	25	1956	580209	580416	1.7	30 - 40	580321	.18-.22
22DE13B	25	1956	580209	580416	1.7	30 - 40	580321	.18-.22
22D14B	25	1957	580209	580416	1.7	30 - 40	580321	.18-.22
22DE14B	25	1957	580209	580416	1.7	30 - 40	580321	.18-.22
22D15B	25	1958	580274	580416	1.7	30 - 40	580321	.18-.22

GALE PRODUCTS - BUCCANEER (Cont'd)

Model No.	H.P.	Year	Magneto No.	Coil No.	Operating Amperage	Continuity No.	Condensor No.	Capacity
3D16	3	1960	580128	580416	1.7	30 - 45	580321	.18-.22
5D17	5	1960	580206	580416	1.7	30 - 45	580321	.18-.22
15D10	15	1960	580270	580197	1.4	42 - 52	580422	.25-.29
25D17	25	1960	580274	580416	1.7	30 - 45	580321	.18-.22
25DE17	25	1960	580274	580416	1.7	30 - 45	580321	.18-.22
35D13	35	1960	580307	580197	1.4	42 - 52	580422	.25-.29
35DE13	35	1960	580307	580197	1.4	42 - 52	580422	.25-.29
60D10	60	1960	580319	580243	1.7	40 - 55	580256	.37-.41
60DE10	60	1960	580319	580243	1.7	40 - 55	580256	.37-.41
3D17	3	1961	580128	580416	1.7	40 - 55	580321	.18-.22
5D18	5	1961	580206	580416	1.7	40 - 55	580321	.18-.22
5D19	5	1961	580206	580416	1.7	40 - 55	580321	.18-.22
5D21	5	1961	580206	580416	1.7	40 - 55	580321	.18-.22
15D11	15	1961	580270	580197	1.4	42 - 52	580422	.25-.29
15D12	15	1961	580270	580197	1.4	42 - 52	580422	.25-.29
25D18	25	1961	580274	580416	1.7	30 - 45	580321	.18-.22
25DE18	25	1961	580274	580416	1.7	30 - 45	580321	.18-.22
25D20	25	1961	580274	580416	1.7	30 - 45	580321	.18-.22
25DE20	25	1961	580274	580416	1.7	30 - 45	580321	.18-.22
40D14	40	1961	580333	580197	1.4	42 - 52	580321	.18-.22
40DE14	40	1961	580333	580197	1.4	42 - 52	580321	.18-.22
60D11	60	1961	580319	580243	1.7	40 - 55	580256	.37-.41
60DE11	60	1961	580319	580243	1.7	40 - 55	580256	.37-.41
60D12	60	1961	580319	580243	1.7	40 - 55	580256	.37-.41
60DE12	60	1961	580319	580243	1.7	40 - 55	580256	.37-.41

GALE PRODUCTS - BUCCANEER (Cont'd)

Model No.	H.P.	Year	Magneto No.	Coil No.	Operating Amperage	Continuity No.	Condensor No.	Capacity
3D18	3	1962	580128	580416	1.7	30 - 45	580321	.18-.22
5D20	5	1962	580206	580416	1.7	30 - 45	580321	.18-.22
15D13	15	1962	580434	580416	1.7	30 - 45	580422	.25-.29
15D14	15	1962	580254	580416	1.7	30 - 45	580321	.18-.22
25D19	25	1962	580274	580416	1.7	30 - 45	580321	.18-.22
25DE19	25	1962	580274	580416	1.7	30 - 45	580321	.18-.22
40D15	40	1962	580415	580416	1.7	30 - 45	580422	.25-.29
40DE15	40	1962	580415	580416	1.7	30 - 45	580422	.25-.29
60DE13	60	1962	580319	580243	1.7	40 - 55	580256	.37-.41
60DG13	60	1962	580319	580243	1.7	40 - 55	580256	.37-.41

GALE PRODUCTS - BUCCANEER (Cont'd)

Model No.	H. P.	Year	Magneto No.	Coil No.	Operating Amperage	Continuity Min. Max.	Condenser No.	Capacity Microfarads
22DE15B	25	1958	580274	580416	1.7	30 - 40	580321	.18-.22
22D16B	25	1959	580274	580416	1.7	30 - 40	580321	.18-.22
22DE16B	25	1959	580274	580416	1.7	30 - 40	580321	.18-.22
35DE10B	35	1958	580333	580197	1.4	42 - 52	580321	.18-.22
35D11B	35	1959	580333	580197	1.4	42 - 52	580321	.18-.22
35DE11B	35	1959	580333	580197	1.4	42 - 52	580321	.18-.22
35D12B	35	1959	580333	580197	1.4	42 - 52	580321	.18-.22
35DE12B	35	1959	580333	580197	1.4	42 - 52	580321	.18-.22

WARD'S - "SEA KING"

Model No.	H.P.	Year	Magneto No.	Coil No.	Operating Amperage	Continuity Min. Max.	Condenser No.	Capacity Microfarads
84GG9003A	1.5	1948-49	580032	375189	1.9	30 - 45	300153	.15-.205
94GG9003A	1.5	1949-50	580032	375189	1.9	30 - 45	300153	.15-.205
64GG9005	3	1945-46	590189	375189	1.9	30 - 45	300153	.15-.205
74GG9005A	3	1947	590189	375189	1.9	30 - 45	300153	.15-.205
74GG9006	3	1947-48	590189	375189	1.9	30 - 45	300153	.15-.205
84GG9007A	3	1948-49	590189	375189	1.9	30 - 45	300153	.15-.205
94GG9009A	3	1949-50	580077	375189	1.9	30 - 45	300153	.15-.205
15GG9004A	3	1951	580128	580416	1.7	30 - 40	580321	.18-.22
25GG9004A	3	1952	580128	580416	1.7	30 - 40	580321	.18-.22
35GG9004A	3	1953	580128	580416	1.7	30 - 40	580321	.18-.22
35GG9004B	3	1953	580128	580416	1.7	30 - 40	580321	.18-.22
45GG9004A	3	1954	580128	580416	1.7	30 - 40	580321	.18-.22
GG9004A	3	1955	580128	580416	1.7	30 - 40	580321	.18-.22
GG9004B	3	1955	580128	580416	1.7	30 - 40	580321	.18-.22
GG9000A	3	1956	580128	580416	1.7	30 - 40	580321	.18-.22
GG9006A	3	1957	580128	580416	1.7	30 - 40	580321	.18-.22
GG8962A	3	1958	580128	580416	1.7	30 - 40	580321	.18-.22
GG8919A	3	1959	580128	580416	1.7	30 - 40	580321	.18-.22
64GG9010	5	1946	590181	375189	1.9	30 - 45	300153	.15-.205
64GG9011	5	1946	590181	375189	1.9	30 - 45	300153	.15-.205
74GG9011A	5	1947	590181	375189	1.9	30 - 45	300153	.15-.205
74GG9012	5	1947-48	590181	375189	1.9	30 - 45	300153	.15-.205
84GG9014A	5	1948	590181	375189	1.9	30 - 45	300153	.15-.205
94GG9014A	5	1949-50	590181	375189	1.9	30 - 45	300153	.15-.205

WARD'S - "SEA KING" (Cont'd)

Model No.	H.P.	Year	Magneto No.	Coil No.	Operating Amperage	Continuity Min.-Max.	Condenser No.	Capacity Microfarads
15GG9014A	5	1951	580120	580416	1.7	30 - 40	580321	.18-.22
35GG9014A	5	1953	580120	580416	1.7	30 - 40	580321	.18-.22
45GG9014A	5	1954	580120	580416	1.7	30 - 40	580321	.18-.22
GG9001A	5	1955	580120	580416	1.7	30 - 40	580321	.18-.22
GG9001B	5	1955	580120	580416	1.7	30 - 40	580321	.18-.22
15GG9015A	5	1951	580120	580416	1.7	30 - 40	580321	.18-.22
25GG9015A	5	1952	580120	580416	1.7	30 - 40	580321	.18-.22
35GG9015A	5	1953	580120	580416	1.7	30 - 40	580321	.18-.22
45GG9015A	5	1954	580120	580416	1.7	30 - 40	580321	.18-.22
GG9013A	5	1955	580183	580416	1.7	30 - 40	580321	.18-.22
GG9001C	5	1955-56	580120	580416	1.7	30 - 40	580321	.18-.22
GG9002A	5	1956	580182	580416	1.7	30 - 40	580321	.18-.22
GG9002B	5	1956	580182	580416	1.7	30 - 40	580321	.18-.22
GG9003A	5	1957	580182	580416	1.7	30 - 40	580321	.18-.22
GG8960A	5	1957	580182	580416	1.7	30 - 40	580321	.18-.22
GG8977A	5	1958	580206	580416	1.7	30 - 40	580321	.18-.22
GG8963A	5	1959	580120	580416	1.7	30 - 40	580321	.18-.22
GG8934A	5	1959	580206	580416	1.7	30 - 40	580321	.18-.22
84GG9017A	12	1948	580047	580040	1.6	34 - 46	300153	.15-.205
94GG9017A	12	1949-50	580047	580040	1.6	34 - 46	300153	.15-.205
15GG9017A	12	1951	580120	580416	1.7	34 - 46	580321	.18-.22
35GG9017A	12	1953	580120	580416	1.7	34 - 46	580321	.18-.22
15GG9018A	12	1951	580120	580416	1.7	34 - 46	580321	.18-.22
25GG9018A	12	1952	580120	580416	1.7	34 - 46	580321	.18-.22
35GG9018A	12	1953	580120	580416	1.7	34 - 46	580321	.18-.22

WARD'S - "SEA KING" (Cont'd)

Model No.	H.P.	Year	Magneto No.	Coil No.	Operating Amperage	Continuity Min. Max.	Condenser No.	Capacity Microfarads
GG9016A	12	1954-55	580153	580416	1.7	30 - 40	580321	.18-.22
GG9016B	12	1956	580207	580416	1.7	30 - 40	580321	.18-.22
GG9016C	12	1957	580207	580416	1.7	30 - 40	580321	.18-.22
GG8978A	12	1957	580207	580416	1.7	30 - 40	580321	.18-.22
GG9021A	12	1956	580207	580416	1.7	30 - 40	580321	.18-.22
GG9021B	12	1956	580207	580416	1.7	30 - 40	580321	.18-.22
GG9024A	12	1956	580207	580416	1.7	30 - 40	580321	.18-.22
GG8971A	12	1957	580207	580416	1.7	30 - 40	580321	.18-.22
GG8971B	12	1957	580207	580416	1.7	30 - 40	580321	.18-.22
GG9005A	12	1957	580207	580416	1.7	30 - 40	580321	.18-.22
GG8978A	12	1958	580207	580416	1.7	30 - 40	580321	.18-.22
GG8981A	12	1958	580254	580416	1.7	30 - 40	580321	.18-.22
GG8935A	12	1959	580254	580416	1.7	30 - 40	580321	.18-.22
GG9019A	22	1955	580180	580416	1.7	30 - 40	580321	.18-.22
GG9020A	22	1955	580180	580416	1.7	30 - 40	580321	.18-.22
GG9019B	22	1955	580180	580416	1.7	30 - 40	580321	.18-.22
GG9020B	22	1955	580180	580416	1.7	30 - 40	580321	.18-.22
GG9022A	25	1956	580209	580416	1.7	30 - 40	580321	.18-.22
GG9022B	25	1956	580209	580416	1.7	30 - 40	580321	.18-.22
GG9023A	25	1956	580209	580416	1.7	30 - 40	580321	.18-.22
GG9023B	25	1956	580209	580416	1.7	30 - 40	580321	.18-.22
GG9025A	25	1957	580209	580416	1.7	30 - 40	580321	.18-.22
GG9026A	25	1957	580209	580416	1.7	30 - 40	580321	.18-.22
GG8985A	25	1958	580274	580416	1.7	30 - 40	580321	.18-.22

WARD'S - "SEA KING" (Cont'd)

Model No.	H.P.	Year	Magneto No.	Coil No.	Operating Amperage	Continuity No.	Condensor No.	Capacity
GG8804A	3	1960	580128	580416	1.7	30 - 45	580321	.18-.22
GG8822A	5	1960	580206	580416	1.7	30 - 45	580321	.18-.22
GG8823A	15	1960	580270	580197	1.4	42 - 52	580422	.25-.29
GG8834A	25	1960	580274	580416	1.7	30 - 45	580321	.18-.22
GG8835A	25	1960	580274	580416	1.7	30 - 45	580321	.18-.22
GG8836A	35	1960	580307	580197	1.4	42 - 52	580422	.25-.29
GG8837A	35	1960	580307	580197	1.4	42 - 52	580422	.25-.29
-	60	1960	580319	580243	1.7	40 - 55	580256	.37-.41
GG8850A	60	1960	580319	580243	1.7	40 - 55	580256	.37-.41
GG18735A	3	1961	580128	580416	1.7	40 - 55	580321	.18-.22
GG18736A	5	1961	580206	580416	1.7	40 - 55	580321	.18-.22
GG18736B	5	1961	580206	580416	1.7	40 - 55	580321	.18-.22
GG18736C	5	1961	580206	580416	1.7	40 - 55	580321	.18-.22
GG18737A	15	1961	580270	580197	1.4	42 - 52	580422	.25-.29
GG18737B	15	1961	580270	580197	1.4	42 - 52	580422	.25-.29
GG18738A	25	1961	580274	580416	1.7	30 - 45	580321	.18-.22
GG18740A	25	1961	580274	580416	1.7	30 - 45	580321	.18-.22
GG18738B	25	1961	580274	580416	1.7	30 - 45	580321	.18-.22
GG18740B	25	1961	580274	580416	1.7	30 - 45	580321	.18-.22
GG18742A	40	1961	580333	580197	1.4	42 - 52	580321	.18-.22
GG18744A	40	1961	580333	580197	1.4	42 - 52	580321	.18-.22
-	60	1961	580319	580243	1.7	40 - 55	580256	.37-.41
GG18746A	60	1961	580319	580243	1.7	40 - 55	580256	.37-.41
-	60	1961	580319	580243	1.7	40 - 55	580256	.37-.41
GG18748A	60	1961	580319	580243	1.7	40 - 55	580256	.37-.41

WARD'S - "SEA KING" (Cont'd)

Model No.	H.P.	Year	Magneto No.	Coil No.	Operating Amperage	Continuity No.	Condensor No.	Capacity
GG18735B	3	1962	580128	580416	1.7	30 - 45	580321	.18-.22
GG18736D	5	1962	580206	580416	1.7	30 - 45	580321	.18-.22
GG18737C	15	1962	580434	580416	1.7	30 - 45	580422	.25-.29
GG18737D	15	1962	580254	580416	1.7	30 - 45	580321	.18-.22
GG18738C	25	1962	580274	580416	1.7	30 - 45	580321	.18-.22
-	25	1962	580274	580416	1.7	30 - 45	580321	.18-.22
GG18742B	40	1962	580415	580416	1.7	30 - 45	580422	.25-.29
GG18744B	40	1962	580415	580416	1.7	30 - 45	580422	.25-.29
GG18746C	60	1962	580319	580243	1.7	40 - 55	580256	.37-.41
GG18748C	60	1962	580319	580243	1.7	40 - 55	580256	.37-.41

WARD'S - "SEA KING" (Cont'd)

Model No.	H. P.	Year	Magneto No.	Coil No.	Operating Amperage	Continuity Min. Max.	Condenser No.	Capacity Microfarads
GG8992A	25	1958	580274	580416	1.7	30 - 40	580321	.18-.22
GG8937A	25	1959	580274	580416	1.7	30 - 40	580321	.18-.22
GG8938A	25	1959	580274	580416	1.7	30 - 40	580321	.18-.22
GG8997A	35	1958	580333	580197	1.4	42 - 52	580321	.18-.22
GG8942A	35	1959	580333	580197	1.4	42 - 52	580321	.18-.22
GG8952A	35	1959	580333	580197	1.4	42 - 52	580321	.18-.22
GG8942B	35	1959	580333	580197	1.4	42 - 52	580321	.18-.22
GG8952B	35	1959	580333	580197	1.4	42 - 52	580321	.18-.22

ELGIN OUTBOARD MOTORS

Motor Model No.	H.P.	Year	Wico Coil No.	Operating Amp.	Coil Continuity Min.-Max.	Wico Cond. No.	Cond. Cap. Mfd.
571.58301	1-1/4	1946-51	X5345F	1.50	40 - 60	X5342F	.30 - .34
571.58201	2	1952	X7500	2.10	30 - 50	X5463	.16 - .20
571.58202	2	1953	X7500	2.10	30 - 50	X5463	.16 - .20
571.58211	2	1954-56	X7500	2.10	30 - 50	X5463	.16 - .20
571.58221	2	1957	X7500	2.10	30 - 50	X5463	.16 - .20
571.58231	2	1958	X7500	2.10	30 - 50	X5463	.16 - .20
571.58232	2	1958	X11406	2.10	30 - 50	X9182	.26 - .30
571.58401	2-1/2	1946-51	X7120	1.40	43 - 54	X11397	.16 - .20
571.58501	3-1/2	1947	X5460F	1.50	30 - 50	X5463F	.16 - .20
571.58521	3-1/2	1947-48	X5460F	1.50	30 - 50	X5463F	.16 - .20
571.58541	5	1949	X5460F	1.50	30 - 50	X5463F	.16 - .20
571.58531	5	1950	X7120	1.40	30 - 50	X5463F	.16 - .20
571.58551	5	1950	X5460F	1.50	30 - 50	X5463	.16 - .20
571.58551	5	1950	X7120	1.40	30 - 50	X5463	.16 - .20
571.58561	5	1951-52	X7500	2.10	30 - 50	X5463	.16 - .20
571.58562	5	1953	X7500	2.10	30 - 50	X5463	.16 - .20
571.58571	5	1954-56	X7500	2.10	30 - 50	X5463	.16 - .20
571.58601	5-1/2	1947	X5460F	1.50	30 - 50	X9182	.26 - .30
571.58611	5-1/2	1947	X5460F	1.50	30 - 50	X5463F	.16 - .20
571.58621	5-1/2	1948	X5460F	1.50	30 - 50	X5463F	.16 - .20
571.59501	5-1/2	1956	X7500	2.10	30 - 50	X9327	.26 - .30
571.59521	5-1/2	1957	X7500	2.10	30 - 50	X9327	.26 - .30
571.59531	5-1/2	1958	X7500	2.10	30 - 50	X9327	.26 - .30
571.59532	5-1/2	1958	X11406	2.10	40 - 60	X11397	.16 - .20
571.58721	6	1948	X5460F	1.50	30 - 50	X5463F	.16 - .20

Motor Model No.	H.P.	Year	Wico Coil No.	Operating Amp.	Coil Continuity Min.-Max.	Wico Cond. No.	Cond. Cap. Mfd.
571.58701	6	1950	X5460F	1.50	30 - 50	X5463F	.16 - .20
571.58641	6	1951	X7500	2.10	30 - 50	X5463	.16 - .20
571.58642	6	1953	X7500	2.10	30 - 50	X5463	.16 - .20
571.58651	6	1954	X7500	2.10	30 - 50	X5463	.16 - .20
571.58652	6	1954	X7500	2.10	30 - 50	X5463	.16 - .20
571.58731	7-1/2	1949	X5460F	1.50	30 - 50	X5463F	.16 - .20
571.57741	7-1/2	1950	X7120	1.40	30 - 50	X5463	.16 - .20
571.58751	7-1/2	1951-52	X7500	2.10	30 - 50	X5463	.16 - .20
571.58761	7-1/2	1953	X7500	2.10	30 - 50	X5463	.16 - .20
571.58762	7-1/2	1954	X7500	2.10	30 - 50	X5463	.16 - .20
571.58771	7-1/2	1954	X5700	1.70	40 - 60	X5463	.16 - .20
571.58772	7-1/2	1954-55	X7500	2.10	30 - 50	X5463	.16 - .20
571.58711	7-1/2	1955	X7500	2.10	30 - 50	X5463	.16 - .20
571.59701	7-1/2	1956	X7500	2.10	30 - 50	X9327	.26 - .30
571.58781	7-1/2	1957	X7500	2.10	30 - 50	X5463	.16 - .20
571.59721	7-1/2	1957	X7500	2.10	30 - 50	X9327	.26 - .30
571.59731	7-1/2	1957	X7500	2.10	30 - 50	X9327	.26 - .30
571.58782	7-1/2	1958	X11406	2.10	40 - 60	X11397	.16 - .20
571.59732	7-1/2	1958	X11406	2.10	40 - 60	X11397	.16 - .20
571.58901	12	1955	X7500	2.10	30 - 50	X9327	.26 - .30
571.58911	12	1955	X7500	2.10	30 - 50	X9327	.26 - .30
571.58902	12	1956	X7500	2.10	30 - 50	X9327	.26 - .30
571.58912	12	1956	X7500	2.10	30 - 50	X9327	.26 - .30
571.58921	12	1956-57	X7500	2.10	30 - 50	X9327	.26 - .30
571.58941	12	1957	X7500	2.10	30 - 50	X9327	.26 - .30

ELGIN OUTBOARD MOTORS (Cont'd)

Motor Model No.	H. P.	Year	Wico Coil No.	Operating Amp.	Coil Continuity Min.-Max.	Wico Cond. No.	Cond. Cap. Mfd.
571.58942	12	1957	X7500	2.10	30 - 50	X9327	.26 - .30
571.58951	12	1957	X7500	2.10	30 - 50	X9327	.26 - .30
571.58952	12	1957	X7500	2.10	30 - 50	X9327	.26 - .30
571.58931	12	1958	X11406	2.10	40 - 60	X11397	.16 - .20
571.58961	12	1958	X7500	2.10	30 - 50	X9327	.26 - .30
571.58962	12	1958	X7500	2.10	30 - 50	X9327	.26 - .30
571.58971	12	1958	X7500	2.10	30 - 50	X9327	.26 - .30
571.58972	12	1958	X7500	2.10	30 - 50	X9327	.26 - .30

ELGIN OUTBOARD MOTORS (Cont'd)

Motor Model No.	H. P.	Year	Fairbanks-Morse Coil No.	Operating Amp.	Coil Continuity Min.-Max.	Fairbanks-Morse Cond. No.	Cond. Cap. Mfd.
571.58821	16	1950-51	DX2477	1.25	40 - 60	V2433	.38 - .43
571.58841	16	1950-51	DX2477	1.25	40 - 60	V2433	.38 - .43
571.58822	16	1952	DX2477	1.25	40 - 60	V2433	.38 - .43
571.58842	16	1952	DX2477	1.25	40 - 60	V2433	.38 - .43
571.58823	16	1953	EX2477	1.40	40 - 60	S2433	.28 - .33
571.58843	16	1953	EX2477	1.40	40 - 60	S2433	.28 - .33
571.58844	16	1953	EX2477	1.40	40 - 60	S2433	.28 - .33
571.58824	16	1954	EX2477	1.40	40 - 60	S2433	.28 - .33
571.58851	16	1954	EX2477	1.40	40 - 60	S2433	.28 - .33
571.58861	16	1954	EX2477	1.40	40 - 60	S2433	.28 - .33
571.59402	25	1956	LX2477	1.50	40 - 60	S2433	.28 - .33
571.59403	25	1956	LX2477	1.50	40 - 60	S2433	.28 - .33
571.59412	25	1956	LX2477	1.50	40 - 60	S2433	.28 - .33
571.59413	25	1956	LX2477	1.50	40 - 60	S2433	.28 - .33
571.59601	25	1956	LX2477	1.50	40 - 60	S2433	.28 - .33
571.59611	25	1956	LX2477	1.50	40 - 60	S2433	.28 - .33
571.59421	30	1957	LX2477	1.50	40 - 60	S2433	.28 - .33
571.59431	30	1957	LX2477	1.50	40 - 60	S2433	.28 - .33
571.59621	30	1957	LX2477	1.50	40 - 60	S2433	.28 - .33
571.59631	30	1957	LX2477	1.50	40 - 60	S2433	.28 - .33
571.59801	30	1957	LX2477	1.50	50 - 60	S2433	.28 - .33
571.59811	30	1957	LX2477	1.50	40 - 60	S2433	.28 - .33
571.59441	35	1958	LX2477	1.50	40 - 60	S2433	.28 - .33
571.59451	35	1958	LX2477	1.50	40 - 60	S2433	.28 - .33

ELGIN OUTBOARD MOTORS (Cont'd)

Model Number	H.P.	Year	Ignition Mfg.	Coil Number	Operating Amperage	Continuity Min. Max.	Condenser Number	Capacity Microfarads
571.59821	35	1958	Wico	X11563	0.75	40 - 60	X11337	.26-.30
571.59831	35	1958	Wico	X11563	0.75	40 - 60	X11337	.26-.30
571.59901	35	1958	Wico	X11563	0.75	40 - 60	X11337	.26-.30
571.59911	35	1958	Wico	X11563	0.75	40 - 60	X11337	.26-.30
574.60250	25	1959	Phelon	FG3755	2.5	40 - 60	FG3478	.18-.22
574.60270	25	1959	Phelon	FG3755	2.5	40 - 60	FG3478	.18-.22
574.60400	40	1959	Phelon	FG3755	2.5	40 - 60	FG3478	.18-.22
574.60420	40	1959	Phelon	FG3755	2.5	40 - 60	FG3478	.18-.22
574.60600	60	1959	Phelon	FG3681	1.8	55 - 75	FG3044	.24-.28
574.60610	60	1959	Phelon	FG3681	1.8	55 - 75	FG3044	.24-.28

ELGIN OUTBOARD MOTORS (Cont'd)

Model No.	HP	Year	Coil No.	Coil Manf.	Manf's No.	Oper. Amp.	Prim. Res. Min.-Max.	Sec. Cont. Min.-Max.	Cond. No.	Cond. Manf.	Manfs. No.	Capacity Micro-farads
A6BB	3.6	1960	138-134	Phelon	FG3689	2.5		40 - 60	138-115	Phelon	FG3693	.15-.19
A6KB	6.0	1960	134-134	McCul	Same	1.9		30 - 45	134-115	Wico	X12293	.18-.22
C6EB	7.5	1960	134-134	McCul	Same	1.9		30 - 45	134-115	Wico	X12293	.18-.22
A6FB	12.	1960	139-134	Phelon	FG4128	2.5		40 - 60	138-115	Phelon	FG3693	.15-.19
A6GB	25 M	1960	3685-113	Wico	X11352	2.0		40 - 60	3685-115	Wico	X11362	.26-.30
B6GB	25M	1960	3685-113	Wico	X11352	2.0		40 - 60	3685-115	Wico	X11362	.26-.30
C6GB	25E	1960	336B-134	McCul	Same	1.4	.55-.85	40 - 60	335B-115	Wico	X12264	.26-.30
D6GB	25E	1960	436B-134	McCul	Same	1.4	.55-.85	40 - 60	335B-115	Wico	X12264	.26-.30
A6HB	40M	1960	3685-113	Wico	X11352	2.0		40 - 60	3685-115	Wico	XX11362	.26-.30
B6HB	40M	1960	3685-113	Wico	X11352	2.0		40 - 60	3685-115	Wico	X11362	.26-.30
C6HB	40E	1960	336B-134	McCul	Same	1.4	.55-.85	40 - 60	335B-115	Wico	X12264	.26-.30
D6HB	40E	1960	436B-134	McCul	Same	1.4	.55-.85	40 - 60	335B-115	Wico	X12264	.26-.30
C6JB	60	1960	532-134	McCul	Same	1.4		45 - 60	332B-115	McCul	332B-115	.25-.27
D6JB	60	1960	532-134	McCul	Same	1.4		45 - 60	332B-115	McCul	332B-115	.25-.27
61600310	3.6	1961	138-134	Phelon	FG3689	2.5		40 - 60	138-115	Phelon	FG3693	.15-.19
61600610	6.0	1961	A3EC-134	McCul	Same	2.5		45 - 60	A3EC-115	Phelon	FG4477	.15-.19
61600710	7.5	1961	A3EC-134	McCul	Same	2.5		45 - 60	A3EC-115	Phelon	FG4477	.15-.19
61601210	14.1	1961	139-134	Phelon	FG4128	2.5		40 - 60	138-115	Phelon	FG3693	.15-.19
61602510	27.7M	1961	3685-113	Wico	X11352	2.0		40 - 60	3685-115	Wico	X11362	.26-.30
61602510	27.7	1961	3685-113	Wico	X11352	2.0		40 - 60	3685-115	Wico	X11362	.26-.30
61602530	27.7E	1961	C3HC-134	McCul	Same	1.4	.55-.85	45 - 55	335B-115	Wico	X12264	.26-.30
61602530	27.7E	1961	D3HC-134	McCul	Same	1.4	.55-.85	45 - 55	335B-115	Wico	X12264	.26-.30
61604030	43.7E	1961	C3HC-134	McCul	Same	1.4	.55-.85	45 - 55	335B-115	Wico	X12264	.26-.30
61604040	43.7E	1961	D3HC-134	McCul	Same	1.4	.55-.85	45 - 55	335B-115	Wico	X12264	.26-.30
61607030	75.2E	1961	C3JB-134	McCul	Same	1.4	.55-.85	45 - 55	332B-115	McCul	Same	.25-.27
61607040	75.2E	1961	C3JB-134	McCul	Same	1.4	.55-.85	45 - 55	332B-115	McCul	Same	.25-.27

** Fairbanks-Morse

ELGIN OUTBOARD MOTORS

* Wico

Motor Model No.	H.P.	Year	Coil No.	Operating Amp.	Continuity Min. Max.	Cond. No.	Capacity Microfarads
571.58241	2	1959	* X11406	2.1	40 - 60	* X11397	.16-.20
571.58791	7-1/2	1959	* X11406	2.1	40 - 60	* X11397	.16-.20
571.58801	12	1959	* X11406	2.1	40 - 60	* X11397	.16-.20
571.58811	12	1959	* X11406	2.1	40 - 60	* X11397	.16-.20
571.58802	12	1959	* X11406	2.1	40 - 60	* X11397	.16-.20
571.58812	12	1959	* X11406	2.1	40 - 60	* X11397	.16-.20
571.58963	12	1959	* X11406	2.1	40 - 60	* X11397	.16-.20
571.58973	12	1959	* X11406	2.1	40 - 60	* X11397	.16-.20
571.58981	12	1959	* X11406	2.1	40 - 60	* X11397	.16-.20
571.58991	12	1959	* X11406	2.1	40 - 60	* X11397	.16-.20
571.59541	5-1/2	1959	* X11406	2.1	40 - 60	* X11397	.16-.20
571.59741	7-1/2	1959	* X11406	2.1	40 - 60	* X11397	.16-.20
571.58321	2	1960	* X11406	2.1	40 - 60	* X11397	.16-.20
571.59221	2	1960	* X11406	2.1	40 - 60	* X11397	.16-.20
571.59271	7-1/2	1960	* X11406	2.1	40 - 60	* X11397	.16-.20
571.59281	7-1/2	1960	* X11406	2.1	40 - 60	* X11397	.16-.20
571.59301	8	1960	* X11406	2.1	40 - 60	* X11397	.16-.20
571.59551	12	1960	* X11406	2.1	40 - 60	* X11397	.16-.20
571.59641	18	1960	* X12302	2.2	40 - 55	* X12303	.16-.20
571.59651	18	1960	* X12302	2.2	40 - 55	* X12303	.16-.20
571.59791	7-1/2	1960	* X11406	2.1	40 - 60	* X11397	.16-.20
571.59881	12	1960	* X11406	2.1	40 - 60	* X11397	.16-.20
571.58322	2	1961	* X12660	1.8	40 - 55	* X12174	.16-.20
571.58331	2	1962	* X12660	1.8	40 - 55	* X12174	.16-.20
571.58341	7-1/2	1962	* X11406	2.1	40 - 60	* X11397	.16-.20
571.58351	3-1/2	1962	* X12660	1.8	40 - 55	* X12174	.16-.20

ELGIN OUTBOARD MOTORS (Cont'd)

Model No.	HP	Year	Coil No.	Coil Manf.	Manf's. No.	Oper. Amp.	Prim. Res. Min. Max.	Sec. Cont. Min. Max.	Cond. No.	Cond. Manf.	Manfs. No.	Capacity Micro-farads
62600310	3.6	1962	138-134	Phel	FG3689	2.5		40-60	138-115	Phel	FG3693	.15-.19
62600610	6.0	1962	A3EC-134	McC	Same	2.5		45-60	A3EC-115	Phel	FG4477	.15-.19
62600710	7.5	1962	A3EC-134	McC	Same	2.5		45-60	A3EC-115	Phel	FG4477	.15-.19
62601410	14.1	1962	139-134	Phel	FG4128	2.5		40-60	138-115	Phel	FG3693	.15-.19
62602810	27.7M	1962	3685-113	Wico	X11352	2.0	.55-.85	40-60	3685-115	Wico	X11362	.26-.30
62602830	27.7E	1962	C3HC-134	McC	Same	1.4		45-55	335B-115	Wico	X12264	.26-.30
	27.7E	top 1962	D3HC-134	McC	Same	1.4	.55-.85	45-55	335B-115	Wico	X12264	.26-.30
	27.7E	bot 1962	D3HC-134	McC	Same	1.4	.55-.85	45-55	335B-115	Wico	X12264	.26-.30
62604430	43.7E	1962	C3HC-134	McC	Same	1.4	.55-.85	45-55	332B-115	McC	Same	.25-.27
62604440	43.7E	1962	D3HC-134	McC	Same	1.4	.55-.85	45-55	332B-115	McC	Same	.25-.27
62607530	75.2E	1962	C3LC-134	McC	Same	1.4	.55-.85	45-55	332B-115	McC	Same	.25-.27
62607540	75.2E	1962	C3LC-134	McC	Same	1.4	.55-.85	45-55	332B-115	McC	Same	.25-.27

COMMODORE

* Wico

** Fairbanks-Morse

Motor Model No.	H. P.	Year	Coil No.	Operating Amp.	Continuity Min.-Max.	Cond. No.	Cond. Capacity Microfarads
23201	2	1961 & 1962	* X12660	1.8	40 - 55	* X12174	.16-.20
73201	7-1/2	1961 & 1962	* X11406	2.1	40 - 60	* X11397	.16-.20
103201	10	1961 & 1962	* X11406	2.1	40 - 60	* X11397	.16-.20
183201	18	1961 & 1962	* X12302	2.2	40 - 55	* X12303	
403201	40	1961 & 1962	** LX2477	1.5	40 - 60	** S2433	.28-.32

FIRESTONE

2291	2	1960	* X11406	2.1	40 - 60	* X11397	.16-.20
72001	7-1/2	1960	* X11406	2.1	40 - 60	* X11397	.16-.20
72002	7-1/2	1960	* X11406	2.1	40 - 60	* X11397	.16-.20
82001	8	1960	* X11406	2.1	40 - 60	* X11397	.16-.20
122021	12	1960	* X11406	2.1	40 - 60	* X11397	.16-.20
122022	12	1960	* X11406	2.1	40 - 60	* X11397	.16-.20
252121	25	1960	** LX2477	1.5	40 - 60	** S2433	.28-.32
402041	40	1960	* X11563	.75	40 - 60	* X11337	.26-.30
402941	40	1960	* X11563	.75	40 - 60	* X11337	.26-.30
2292	2	1961	* X12660	1.8	40 - 55	* X12174	.16-.20
72002	7-1/2	1961	* X11406	2.1	40 - 60	* X11397	.16-.20
82001	8	1961	* X11406	2.1	40 - 60	* X11397	.16-.20
122023	12	1961	* X11406	2.1	40 - 60	* X11397	.16-.20
252121	25	1961	** LX2477	1.5	40 - 60	** S2433	.28-.32
402042	40	1961	* X11563	.75	40 - 60	* X11337	.26-.30
402941	40	1961	* X11563	.75	40 - 60	* X11337	.26-.30

WEST BEND OUTBOARD MOTORS

Motor Model No.	H.P.	Year	Wico Coil No.	Operating Amp.	Coil Continuity Min.-Max.	Wico Cond. No.	Cond. Cap. Mfd.
160211	2	1956	X7500	2.10	30 - 50	X5463	.16 - .20
160221	2	1957	X7500	2.10	30 - 50	X9182	.26 - .30
2801	2	1958	X7500	2.10	30 - 50	X9182	.26 - .30
2802	2	1958	X11406	2.10	40 - 60	X11397	.16 - .20
160501	5-1/2	1956	X7500	2.10	30 - 50	X9327	.26 - .30
160511	5-1/2	1956	X7500	2.10	30 - 50	X9327	.26 - .30
160521	6	1957	X7500	2.10	30 - 50	X9327	.26 - .30
160531	6	1957	X7500	2.10	30 - 50	X9327	.26 - .30
6801	6	1958	X7500	2.10	30 - 50	X9327	.26 - .30
6802	6	1958	X11406	2.10	40 - 60	X11397	.16 - .20
160701	7-1/2	1956	X7500	2.10	30 - 50	X9327	.26 - .30
160711	7-1/2	1956	X7500	2.10	30 - 50	X9327	.26 - .30
160721	8	1957	X7500	2.10	30 - 50	X9327	.26 - .30
160731	8	1957	X7500	2.10	30 - 50	X9327	.26 - .30
8801	8	1958	X7500	2.10	30 - 50	X9327	.26 - .30
8802	8	1958	X11406	2.10	40 - 60	X11397	.16 - .20
160902	12	1956	X7500	2.10	30 - 50	X9327	.26 - .30
160912	12	1956	X7500	2.10	30 - 50	X9327	.26 - .30
160941	12	1957	X7500	2.10	30 - 50	X9327	.26 - .30
160951	12	1957	X7500	2.10	30 - 50	X9327	.26 - .30
12801	12	1958	X7500	2.10	30 - 50	X9327	.26 - .30
12811	12	1958	X7500	2.10	30 - 50	X9327	.26 - .30
12802	12	1958	X11406	2.10	40 - 60	X11397	.16 - .20
12812	12	1958	X11406	2.10	40 - 60	X11397	.16 - .20
35841	35	1958	X11563	0.75	40 - 60	X11337	.26 - .30
35851	35	1958	X11563	0.75	40 - 60	X11337	.26 - .30
35861	35	1958	X11563	0.75	40 - 60	X11337	.26 - .30
35871	35	1958	X11563	0.75	40 - 60	X11337	.26 - .30

WEST BEND OUTBOARD MOTORS (Cont'd)

Motor Model No.	H. P.	Year	Fairbanks-Morse Coil No.	Operating Amp.	Coil Continuity Min.-Max.	Fairbanks-Morse Cond. No.	Cond. Cap. Mfd.
1609403	25	1956	LX2477	1.50	40 - 60	S2433	.28 - .33
1609413	25	1956	LX2477	1.50	40 - 60	S2433	.28 - .33
1609602	25	1956	LX2477	1.50	40 - 60	S2433	.28 - .33
1609612	25	1956	LX2477	1.50	40 - 60	S2433	.28 - .33
160421	30	1957	LX2477	1.50	40 - 60	S2433	.28 - .33
160431	30	1957	LX2477	1.50	40 - 60	S2433	.28 - .33
160621	30	1957	LX2477	1.50	40 - 60	S2433	.28 - .33
160631	30	1957	LX2477	1.50	40 - 60	S2433	.28 - .33
160801	30	1957	LX2477	1.50	40 - 60	S2433	.28 - .33
160811	30	1957	LX2477	1.50	40 - 60	S2433	.28 - .33
35801	35	1958	LX2477	1.50	40 - 60	S2433	.28 - .33
35811	35	1958	LX2477	1.50	40 - 60	S2433	.28 - .33
35821	35	1958	LX2477	1.50	40 - 60	S2433	.28 - .33
35831	35	1958	LX2477	1.50	40 - 60	S2433	.28 - .33
BATTERY IGNITION	40 - 80	1957-60	WICO	0.75	40 - 60	WICO	.26 - .30
			X11563			X11337	

** Fairbanks-Morse

WEST BEND OUTBOARD MOTORS

* Wico

Motor Model No.	H. P.	Year	Coil No.	Operating Amp.	Continuity Min. Max.	Cond. No.	Cond. Capacity Microfarads
2901	2	1959	* X11406	2.1	40 - 60	* X11397	.16-.20
6901	6	1959	* X11406	2.1	40 - 60	* X11397	.16-.20
6911	6	1959	* X11406	2.1	40 - 60	* X11397	.16-.20
6902	6	1959	* X11406	2.1	40 - 60	* X11397	.16-.20
6912	6	1959	* X11406	2.1	40 - 60	* X11397	.16-.20
8901	8	1959	* X11406	2.1	40 - 60	* X11397	.16-.20
8911	8	1959	* X11406	2.1	40 - 60	* X11397	.16-.20
8902	8	1959	* X11406	2.1	40 - 60	* X11397	.16-.20
8912	8	1959	* X11406	2.1	40 - 60	* X11397	.16-.20
12901	12	1959	* X11406	2.1	40 - 60	* X11397	.16-.20
12911	12	1959	* X11406	2.1	40 - 60	* X11397	.16-.20
12902	12	1959	* X11406	2.1	40 - 60	* X11397	.16-.20
12912	12	1959	* X11406	2.1	40 - 60	* X11397	.16-.20
16901	16	1959	* X11406	2.1	40 - 60	* X11397	.16-.20
16911	16	1959	* X11406	2.1	40 - 60	* X11397	.16-.20
16902	16	1959	* X11406	2.1	40 - 60	* X11397	.16-.20
16912	16	1959	* X11406	2.1	40 - 60	* X11397	.16-.20
35901	35	1959	** LX2477	1.5	40 - 60	** S2433	.28-.32
35911	35	1959	** LX2477	1.5	40 - 60	** S2433	.28-.32
35921	35	1959	** LX2477	1.5	40 - 60	** S2433	.28-.32
35931	35	1959	** LX2477	1.5	40 - 60	** S2433	.28-.32
35941	35	1959	** LX2477	1.5	40 - 60	** S2433	.28-.32
35951	35	1959	** LX2477	1.5	40 - 60	** S2433	.28-.32
35961	35	1959	* X11563	.75	40 - 60	* X11337	.26-.30
35971	35	1959	* X11563	.75	40 - 60	* X11337	.26-.30
35981	35	1959	* X11563	.75	40 - 60	* X11337	.26-.30

** Fairbanks-Morse

WEST BEND OUTBOARD MOTORS (Cont'd)

* Wico

Motor Model No.	H. P.	Year	Coil. No.	Operating Amp.	Continuity Min. Max.	Cond. No.	Cond. Capacity Microfarad
35991	35	1959	* X11563	.75	40 - 60	* X11337	.26-.30
35982	35	1959	* X11563	.75	40 - 60	* X11337	.26-.30
35992	35	1959	* X11563	.75	40 - 60	* X11337	.26-.30
40901	40	1959	** LX2477	1.5	40 - 60	** S2433	.28-.32
40911	40	1959	** LX2477	1.5	40 - 60	** S2433	.28-.32
40902	40	1959	** LX2477	1.5	40 - 60	** S2433	.28-.32
40912	40	1959	** LX2477	1.5	40 - 60	** S2433	.28-.32
40961	40	1959	* X11563	.75	40 - 60	* X11337	.26-.30
40971	40	1959	* X11563	.75	40 - 60	* X11337	.26-.30
40962	40	1959	* X11563	.75	40 - 60	* X11337	.26-.30
40972	40	1959	* X11563	.75	40 - 60	* X11337	.26-.30
40963	40	1959	* X11563	.75	40 - 60	* X11337	.26-.30
40973	40	1959	* X11563	.75	40 - 60	* X11337	.26-.30
2901	2	1960	* X11406	2.1	40 - 60	* X11397	.16-.20
7001	7-1/2	1960	* X11406	2.1	40 - 60	* X11397	.16-.20
7002	7-1/2	1960	* X11406	2.1	40 - 60	* X11397	.16-.20
8001	8	1960	* X11406	2.1	40 - 60	* X11397	.16-.20
12021	12	1960	* X11406	2.1	40 - 60	* X11397	.16-.20
12031	12	1960	* X11406	2.1	40 - 60	* X11397	.16-.20
18001	18	1960	* X12302	2.2	40 - 55	* X12303	.16-.20
18011	18	1960	* X12302	2.2	40 - 55	* X12303	.16-.20
25021	25	1960	** LX2477	1.5	40 - 60	** S 2433	.28-.32
25031	25	1960	** LX2477	1.5	40 - 60	** S 2433	.28-.32
40001	40	1960	** LX2477	1.5	40 - 60	** S 2433	.28-.32
40011	40	1960	** LX2477	1.5	40 - 60	** S 2433	.28-.32

WEST BEND OUTBOARD MOTORS (Cont'd)

** Fairbanks-Morse

* Wico

Motor Model No.	H. P.	Year	Coil No.	Operating Amp.	Continuity Min.-Max.	Cond. No.	Cond. Capacity Microfarads
40021	40	1960	** LX2477	1.5	40 - 60	** S2433	.28-.32
40031	40	1960	** LX2477	1.5	40 - 60	** S2433	.28-.32
40061	40	1960	* X11563	.75	40 - 60	* X11337	.26-.30
40071	40	1960	* X11563	.75	40 - 60	* X11337	.26-.30
2101	2	1961	* X12660	1.8	40 - 55	* X12174	.16-.20
2102	2	1961	* X11406	2.1	40 - 60	* X11397	.16-.20
7001	7-1/2	1961	* X11406	2.1	40 - 60	* X11397	.16-.20
7002	7-1/2	1961	* X11406	2.1	40 - 60	* X11397	.16-.20
12101	12	1961	* X11406	2.1	40 - 60	* X11397	.16-.20
12102	12	1961	* X11406	2.1	40 - 60	* X11397	.16-.20
18101	18	1961	* X12302	2.2	40 - 55	* X12303	.16-.20
18111	18	1961	* X12302	2.2	40 - 55	* X12303	.16-.20
18102	18	1961	* X12302	2.2	40 - 55	* X12303	.16-.20
18112	18	1961	* X12302	2.2	40 - 55	* X12303	.16-.20
25121	25	1961	** LX2477	1.5	40 - 60	** S2433	.28-.32
25131	25	1961	** LX2477	1.5	40 - 60	** S2433	.28-.32
25122	25	1961	** LX2477	1.5	40 - 60	** S2433	.28-.32
25132	25	1961	** LX2477	1.5	40 - 60	** S2433	.28-.32
40101	40	1961	** LX2477	1.5	40 - 60	** S2433	.28-.32
40111	40	1961	** LX2477	1.5	40 - 60	** S2433	.28-.32
40102	40	1961	** LX2477	1.5	40 - 60	** S2433	.28-.32
40112	40	1961	** LX2477	1.5	40 - 60	** S2433	.28-.32
40121	40	1961	** LX2477	1.5	40 - 60	** S2433	.28-.32
40131	40	1961	** LX2477	1.5	40 - 60	** S2433	.28-.32
40122	40	1961	** LX2477	1.5	40 - 60	** S2433	.28-.32
40132	40	1961	** LX2477	1.5	40 - 60	** S2433	.28-.32

WEST BEND INDUSTRIAL ENGINES

* Wico

** Fairbanks-Morse

Motor Model No.	Coil No.	Operating Amp.	Coil Continuity Min.-Max.	Cond. No.	Cond. Capacity Microfarads
2725	* X11260	1.8	40 - 55	* X11000	.16-.23
2760	* X11260	1.8	40 - 55	* X11000	.16-.23
2761	* X11260	1.8	40 - 55	* X11000	.16-.23
27612	* X11260	1.8	40 - 55	* X11000	.16-.23
2762	* X11260	1.8	40 - 55	* X11000	.16-.23
2763	* X11260	1.8	40 - 55	* X11000	.16-.23
2764	* X11260	1.8	40 - 55	* X11000	.16-.23
2785	* X9055	2.1	35 - 55	* X9100	.26-.30
27882	* X11260	1.8	40 - 55	* X11000	.16-.23
27883	* X11260	1.8	40 - 55	* X11000	.16-.23
27812	* X11260	1.8	40 - 55	* X11000	.16-.23
27813	* X11260	1.8	40 - 55	* X11000	.16-.23
27822	* X11260	1.8	40 - 55	* X11000	.16-.23
27823	* X11260	1.8	40 - 55	* X11000	.16-.23
27824	* X11260	1.8	40 - 55	* X11000	.16-.23
27825	* X11260	1.8	40 - 55	* X11000	.16-.23
27854	* X11260	1.8	40 - 55	* X11000	.16-.23
58001	* X11260	1.8	40 - 55	* X11000	.16-.23
58002	* X11260	1.8	40 - 55	* X11000	.16-.23
58003	* X11260	1.8	40 - 55	* X11000	.16-.23
58004	* X11260	1.8	40 - 55	* X11000	.16-.23
58006	* X11260	1.8	40 - 55	* X11000	.16-.23
58007	* X11260	1.8	40 - 55	* X11000	.16-.23
58008	* X11260	1.8	40 - 55	* X11000	.16-.23
58009	* X11260	1.8	40 - 55	* X12508	.16-.20
58010	* X11260	1.8	40 - 55	* X12508	.16-.20
58011	* X11260	1.8	40 - 55	* X12508	.16-.20
58012	* X11260	1.8	40 - 55	* X12508	.16-.20
58013	* X11260	1.8	40 - 55	* X12508	.16-.20
58015	* X11260	1.8	40 - 55	* X12508	.16-.20
58016	* X11260	1.8	40 - 55	* X11000	.16-.23
58017	* X11260	1.8	40 - 55	* X11000	.16-.23
70001	* X11260	1.8	40 - 55	* X11000	.16-.23
70002	* X11260	1.8	40 - 55	* X11000	.16-.23
70006	* X11260	1.8	40 - 55	* X12508	.16-.20
70007	* X11260	1.8	40 - 55	* X11000	.16-.23
70008	* X11260	1.8	40 - 55	* X11000	.16-.23
70009	* X11260	1.8	40 - 55	* X12508	.16-.20
70010	* X11260	1.8	40 - 55	* X12508	.16-.20
70012	* X11260	1.8	40 - 55	* X12508	.16-.20
70013	* X11260	1.8	40 - 55	* X12508	.16-.20
61001	* X13313	1.8	50 - 60	* X13299	.16-.20
61002	* X13313	1.8	50 - 60	* X13299	.16-.20
82001	* X13313	1.8	50 - 60	* X13299	.16-.20
82002	* X13313	1.8	50 - 60	* X13299	.16-.20

WEST BEND INDUSTRIAL ENGINES

Motor Model No.	Wico Coil No.	Operating Amp.	Coil Continuity Min.-Max.	Wico Cond. No.	Cond. Cap. Mfd.
2700	X7467	1.80	30 - 50	X7461	.10 - .15
2704	X7467	1.80	30 - 50	X7461	.10 - .15
2706	*X9055	2.10	40 - 50	X8959	.16 - .20
2723	*X9055	2.10	40 - 50	X8959	.16 - .20
2726	X11260	1.75	30 - 50	X11000	.16 - .20
2727	X11260	1.75	30 - 50	X11000	.16 - .20
2728	X11260	1.75	30 - 50	X11000	.16 - .20
2729	X11260	1.75	30 - 50	X11000	.16 - .20
2730	X11260	1.75	30 - 50	X11000	.16 - .20
2731	X11260	1.75	30 - 50	X11000	.16 - .20
2732	X11260	1.75	30 - 50	X11000	.16 - .20
2733	X11260	1.75	30 - 50	X11000	.16 - .20
2734	X11260	1.75	30 - 50	X11000	.16 - .20
2735	X11260	1.75	30 - 50	X11000	.16 - .20
2736	X11260	1.75	30 - 50	X11000	.16 - .20
2738	X11260	1.75	30 - 50	X11000	.16 - .20
2740	X11260	1.75	30 - 50	X11000	.16 - .20
2742	X11260	1.75	30 - 50	X11000	.16 - .20
2744	X11260	1.75	30 - 50	X11000	.16 - .20
2752	X7536	1.90	38 - 58	X7529	.16 - .20
2756	*X9055	2.10	35 - 55	X9100	.26 - .30
27562	X11260	1.75	30 - 50	X11000	.16 - .20
2770	X7536	1.90	38 - 58	X9100	.26 - .30
2770	*X9055	2.10	35 - 55	X9100	.26 - .30
2771	*X9055	2.10	35 - 55	X9100	.26 - .30
27712	X11260	1.75	30 - 50	X11000	.16 - .20
2772	X7536	1.90	38 - 58	X9100	.26 - .30
2772	*X9055	2.10	35 - 55	X9100	.26 - .30
2772	X11260	1.75	30 - 50	X11000	.16 - .20
27722	X11260	1.75	30 - 50	X11000	.16 - .20
2774	X7536	1.90	38 - 58	X9100	.26 - .30
2774	*X9055	2.10	35 - 55	X9100	.26 - .30
2774	X11260	1.75	30 - 50	X11000	.16 - .20
27742	X11260	1.75	30 - 50	X11000	.16 - .20
2775	*X9055	2.10	35 - 55	X9100	.26 - .30
2777	X7467	1.80	30 - 50	X7461	.10 - .15
2778	*X9055	2.10	35 - 55	X9100	.26 - .30
2778-1	*X9055	2.10	35 - 55	X9100	.26 - .30
2779	*X9055	2.10	35 - 55	X9100	.26 - .30
2780	*X9055	2.10	35 - 55	X9100	.26 - .30
2781	*X9055	2.10	35 - 55	X9100	.26 - .30
2782	*X9055	2.10	35 - 55	X9100	.26 - .30
2783	*X9055	2.10	35 - 55	X9100	.26 - .30
2784	*X9055	2.10	35 - 55	X9100	.26 - .30
2785	*X9055	2.10	35 - 55	X9100	.26 - .30
27852	X11260	1.75	30 - 50	X11000	.16 - .20
2786	*X9055	2.10	35 - 55	X9100	.26 - .30
2787	*X9055	2.10	35 - 55	X9100	.26 - .30
2788	*X9055	2.10	35 - 55	X9100	.26 - .30
2788	X11260	1.75	30 - 50	X11000	.16 - .20

* Replace with Wico Coil No. X9692.

GOODYEAR'S - "SEA BEE"

Model No.	H.P.	Year	Magneto No.	Coil No.	Operating Amperage	Continuity Min. Max.	Condenser No.	Capacity Microfarads
025-3562	1.5	1948-49	580032	580084	1.6	34 - 46	300153	.15-.205
025-3562A	1.5	1949	580032	580084	1.6	34 - 46	300153	.15-.205
025-3555	3	1945-46	590189	580084	1.6	34 - 46	300153	.15-.205
1G1	3	1947	590189	580084	1.6	34 - 46	300153	.15-.205
1G4	3	1947-48	590189	580084	1.6	34 - 46	300153	.15-.205
025-3563	3	1948-49	590189	580084	1.6	34 - 46	300153	.15-.205
025-3566	3	1949-50	580077	580084	1.6	34 - 46	300153	.15-.205
025-3567 (3D10G)	3	1951-53	580128	580118	1.6	30 - 40	510173	.18-.22
025-3567 (3D11G)	3	1953	580128	580118	1.6	30 - 40	510173	.18-.22
025-3574	3	1954-55	580128	580118	1.6	30 - 40	510173	.18-.22
025-3574 (3D12G)	3	1955	580128	580118	1.6	30 - 40	510173	.18-.22
225-3606 (3D13G)	3	1956	580128	580118	1.6	30 - 40	510173	.18-.22
225-3612 (3D14G)	3	1957	580128	580118	1.6	30 - 40	510173	.18-.22
225-3619 (3619)	3	1958-59	580128	580118	1.6	30 - 40	510173	.18-.22
025-3550	5	1945-46	590181	580084	1.6	34 - 46	300153	.15-.205
2G2	5	1947	590181	580084	1.6	34 - 46	300153	.15-.205
2G3	5	1948	590181	580084	1.6	34 - 46	300153	.15-.205
025-3564	5	1948	590181	580084	1.6	34 - 46	300153	.15-.205
025-3564A	5	1949-50	590181	580084	1.6	34 - 46	300153	.15-.205
025-3569	5	1951-53	580120	580118	1.6	30 - 40	510173	.18-.22
025-3568	5	1951-54	580120	580118	1.6	30 - 40	510173	.18-.22
025-3573	5	1954	580120	580118	1.6	30 - 40	510173	.18-.22
025-3602 (5S11G)	5	1955	580120	580118	1.6	30 - 40	510173	.18-.22
025-3603 (5D11G)	5	1955	580183	580118	1.6	30 - 40	510173	.18-.22

GOODYEAR'S - "SEA BEE" (Cont'd)

Model No.	H. P.	Year	Magneto No.	Coil No.	Operating Amperage	Continuity Min. Max.	Condenser No.	Capacity Microfarads
225-3607 (5S12G)	5	1956	580120	580118	1.6	30 - 40	510173	.18-.22
225-3608 (5D12G)	5	1956	580182	580118	1.6	30 - 40	510173	.18-.22
225-3608 (5D13G)	5	1956	580182	580118	1.6	30 - 40	510173	.18-.22
225-3613 (5S13G)	5	1957	580120	580118	1.6	30 - 40	510173	.18-.22
225-3614 (5D14G)	5	1957	580182	580118	1.6	30 - 40	510173	.18-.22
225-3620	5	1958	580120	580118	1.6	30 - 40	510173	.18-.22
225-3621	5	1958	580206	580118	1.6	30 - 40	510173	.18-.22
225-3450	5	1959	580206	580118	1.6	30 - 40	510173	.18-.22
025-3565	12	1948	580047	580040	1.6	30 - 40	300153	.15-.205
025-3565A	12	1949-50	580047	580040	1.6	30 - 40	300153	.15-.205
025-3570	12	1951-53	580120	580118	1.6	30 - 40	510173	.18-.22
025-3571	12	1951-53	580120	580118	1.6	30 - 40	510173	.18-.22
25-3572	12	1954-55	580153	580118	1.6	30 - 40	510173	.18-.22
225-3609 (12D13G)	12	1956	580207	580118	1.6	30 - 40	510173	.18-.22
225-3609 (12D14G)	12	1956	580207	580118	1.6	30 - 40	510173	.18-.22
225-3615 (12D15G)	12	1957	580207	580118	1.6	30 - 40	510173	.18-.22
225-3615 (12D16G)	12	1957	580207	580118	1.6	30 - 40	510173	.18-.22
226-3622	12	1958	580254	580118	1.6	30 - 40	510173	.18-.22
225-3451	12	1959	580254	580118	1.6	30 - 40	510173	.18-.22
25-3604 (22D10G)	22	1955	580180	580118	1.6	30 - 40	510173	.18-.22
25-3605 (22DE10G)	22	1955	580180	580118	1.6	30 - 40	510173	.18-.22
25-3604 (22E12G)	22	1955	580180	580118	1.6	30 - 40	510173	.18-.22
25-3605 (22DE12G)	22	1955	580180	580118	1.6	30 - 40	510173	.18-.22

Model No.	H. P.	Year	Magneto No.	Coil No.	Operating Amperage	Continuity Min. Max.	Condenser No.	Capacity Microfarads
225-3610 (22D11G)	25	1956	580209	580118	1.6	30 - 40	510173	.18-.22
225-3610 (22D13G)	25	1956	580209	580118	1.6	30 - 40	510173	.18-.22
225-3611 (22DE11G)	25	1956	580209	580118	1.6	30 - 40	510173	.18-.22
225-3611 (22DE13G)	25	1956	580209	580118	1.6	30 - 40	510173	.18-.22
225-3616 (22D14G)	25	1957	580209	580118	1.6	30 - 40	510173	.18-.22
225-3617 (22DE14G)	25	1957	580209	580118	1.6	30 - 40	510173	.18-.22
225-3623	25	1958	580274	580118	1.6	30 - 40	510173	.18-.22
225-3624	25	1958	580274	580118	1.6	30 - 40	510173	.18-.22
225-3452	25	1959	580274	580118	1.6	30 - 40	510173	.18-.22
225-3453	25	1959	580274	580118	1.6	30 - 40	510173	.18-.22
225-3454	35	1959	580275	580197	1.4	42 - 52	510173	.18-.22
225-3455	35	1959	580275	580197	1.4	42 - 52	510173	.18-.22
225-3454A	35	1959	580275	580197	1.4	42 - 52	510173	.18-.22
225-3455A	35	1959	580275	580197	1.4	42 - 52	510173	.18-.22

SPIEGEL'S - "BROOKLURE"

Model No.	H. P.	Year	Magneto No.	Coil No.	Operating Amperage	Continuity Min.-Max.	Condenser No.	Capacity Microfarads
230-50-1	1.5	1950	580032	375189	1.9	30 - 45	300153	.15-.205
230-50-3	3	1950	580077	375189	1.9	30 - 45	300153	.15-.205
230-51-3D	3	1951-53	580128	580416	1.7	30 - 40	580321	.18-.22
230-51-3DA	3	1953-55	580128	580416	1.7	30 - 40	580321	.18-.22
230-51-3DB	3	1955	580128	580416	1.7	30 - 40	580321	.18-.22
50-T-3341	3	1956	580128	580416	1.7	30 - 40	580321	.18-.22
50-T-3337	3	1957	580128	580416	1.7	30 - 40	580321	.18-.22
50-Z-3323	3	1958	580128	580416	1.7	30 - 40	580321	.18-.22
230-50-5	5	1950	590181	375189	1.9	30 - 45	300153	.15-.205
230-51-5S	5	1951-54	580120	580416	1.7	30 - 40	580321	.18-.22
230-51-5D	5	1951-54	580120	580416	1.7	30 - 40	580321	.18-.22
230-55-5D	5	1955	580183	580416	1.7	30 - 40	580321	.18-.22
50-T-3342	5	1956	580120	580416	1.7	30 - 40	580321	.18-.22
50-T-3343	5	1956	580182	580416	1.7	30 - 40	580321	.18-.22
50-T-3343A	5	1956	580182	580416	1.7	30 - 40	580321	.18-.22
50-T-3343B	5	1957	580182	580416	1.7	30 - 40	580321	.18-.22
50-Z-3324	5	1958	580206	580416	1.7	30 - 40	580321	.18-.22
230-50-12	12	1950	580047	580040	1.6	34 - 46	300153	.15-.205
230-51-12D	12	1951-53	580120	580416	1.7	30 - 40	580321	.18-.22
230-51-12S	12	1953	580120	580416	1.7	30 - 40	580321	.18-.22
230-53-12D	12	1954	580153	580416	1.7	30 - 40	580321	.18-.22
50-T-3344	12	1956	580207	580416	1.7	30 - 40	580321	.18-.22

SPIEGEL'S - "BROOKLURE" (Cont'd)

Model No.	H. P.	Year	Magneto No.	Coil No.	Operating Amperage	Continuity Min.-Max.	Condenser No.	Capacity Microfarads
50-T-3338	12	1957	580207	580416	1.7	30 - 40	580321	.18-.22
50-Z-3325	12	1958	580254	580416	1.7	30 - 40	580321	.18-.22
230-55-22DS	22	1955	580180	580416	1.7	30 - 40	580321	.18-.22
230-55-22DE	22	1955	580180	580416	1.7	30 - 40	580321	.18-.22
50-T-3345	25	1956	580209	580416	1.7	30 - 40	580321	.18-.22
50-T-3346	25	1956	580209	580416	1.7	30 - 40	580321	.18-.22
50-T-3339	25	1957	580209	580416	1.7	30 - 40	580321	.18-.22
50-T-3340	25	1957	580209	580416	1.7	30 - 40	580321	.18-.22
50-Z-3326	25	1958	580274	580416	1.7	30 - 40	580321	.18-.22
50-Z-3327	25	1958	580274	580416	1.7	30 - 40	580321	.18-.22

ATLAS - "ROYAL"

Model No.	H.P.	Year	Magneto No.	Coil No.	Operating Amperage	Continuity Min. Max.	Condenser No.	Capacity Microfarads
1A5	1.5	1948-49	580032	580084	1.6	34 - 46	300153	.15-.205
1A9	3	1950	580077	580084	1.6	34 - 46	300153	.15-.205
3D10A	3	1952-53	580128	580118	1.6	30 - 40	510173	.18-.22
3D11A	3	1953-55	580128	580118	1.6	30 - 40	510173	.18-.22
3D12A	3	1955	580128	580118	1.6	30 - 40	510173	.18-.22
3D13A	3	1956	580128	580118	1.6	30 - 40	510173	.18-.22
2A3	5	1947-48	590181	580084	1.6	34 - 46	300153	.15-.205
2A7	5	1949-50	590181	580084	1.6	34 - 46	300153	.15-.205
5D10A	5	1951-54	580120	580118	1.6	30 - 40	510173	.18-.22
5S10A	5	1953-54	580120	580118	1.6	30 - 40	510173	.18-.22
5S11A	5	1955	580120	580118	1.6	30 - 40	510173	.18-.22
5D11A	5	1955	580183	580118	1.6	30 - 40	510173	.18-.22
5D12A	5	1956	580120	580118	1.6	30 - 40	510173	.18-.22
5D13A	5	1956	580182	580118	1.6	30 - 40	510173	.18-.22
2A8	12	1948-50	580047	580040	1.6	30 - 40	300153	.15-.205
12D10A	12	1951-53	580120	580118	1.6	30 - 40	510173	.18-.22
12D11A	12	1954-55	580153	580118	1.6	30 - 40	510173	.18-.22
12D13A	12	1956	580207	580118	1.6	30 - 40	510173	.18-.22
22D10A	22	1955	580180	580118	1.6	30 - 40	510173	.18-.22
22DE10A	22	1955	580180	580118	1.6	30 - 40	510173	.18-.22

ATLAS - "ROYAL" (Cont'd)

Model No.	H.P.	Year	Magneto No.	Coil No.	Operating Amperage	Continuity Min. Max.	Condenser No.	Capacity Microfarads
22D12A	22	1955	580180	580118	1.6	30 - 40	510173	.18-.22
22DE12A	22	1955	580180	580118	1.6	30 - 40	510173	.18-.22
25D11A	25	1956	580209	580118	1.6	30 - 40	510173	.18-.22
25D13A	25	1956	580209	580118	1.6	30 - 40	510173	.18-.22
25DE11A	25	1956	580209	580118	1.6	30 - 40	510173	.18-.22
25DE13A	25	1956	580209	580118	1.6	30 - 40	510173	.18-.22

GAMBLE'S - "HIAWATHA"

Model No.	H.P.	Year	Magneto No.	Coil No.	Operating Amperage	Continuity Min. Max.	Condenser No.	Capacity Microfarads
840-MI-25-7945A	1.5	1948-49	580032	580084	1.6	34 - 46	300153	.15-.205
25-3258	3	1945-46	590189	580084	1.6	34 - 46	300153	.15-.205
25-7955	3	1947	590189	580084	1.6	34 - 46	300153	.15-.205
47-3S	3	1947	590189	580084	1.6	34 - 46	300153	.15-.205
25-7956	3	1947-48	590189	580084	1.6	34 - 46	300153	.15-.205
840-MI-25-7957A	3	1948-49	590189	580084	1.6	34 - 46	300153	.15-.205
050-MI-25-7958A	3	1949-50	580077	580084	1.6	34 - 46	300153	.15-.205
150-MI-25-7959A	3	1951	580128	580118	1.6	30 - 40	510173	.18-.22
350-MI-25-7959B	3	1953	580128	580118	1.6	30 - 40	510173	.18-.22
350-MI-25-7959B	3	1953	580128	580118	1.6	30 - 40	510173	.18-.22
450-MI-25-7959A	3	1954	580128	580118	1.6	30 - 40	510173	.18-.22
550-MI-25-7959A	3	1955	580128	580118	1.6	30 - 40	510173	.18-.22
50-SA	5	1945-46	590181	580084	1.6	34 - 46	300153	.15-.205
50-DLA	5	1945-46	590181	580084	1.6	34 - 46	300153	.15-.205
47-5D	5	1947	590181	580084	1.6	34 - 46	300153	.15-.205
25-7970	5	1947	590181	580084	1.6	34 - 46	300153	.15-.205
25-7971	5	1947-48	590181	580084	1.6	34 - 46	300153	.15-.205
840-MI-25-7972A	5	1948	590181	580084	1.6	34 - 46	300153	.15-.205
940-MI-25-7972A	5	1949-50	590181	580084	1.6	34 - 46	300153	.15-.205
150-MI-25-7973A	5	1951	580120	580118	1.6	30 - 40	510173	.18-.22
250-MI-25-7963A	5	1952	580120	580118	1.6	30 - 40	510173	.18-.22
350-MI-25-7972B	5	1953	580120	580118	1.6	30 - 40	510173	.18-.22
350-MI-25-7973B	5	1953	580120	580118	1.6	30 - 40	510173	.18-.22
450-MI-25-7973A	5	1954	580120	580118	1.6	30 - 40	510173	.18-.22

GAMBLE'S - "HIAWATHA" (Cont'd)

Model No.	H. P.	Year	Magneto No.	Coil No.	Operating Amperage	Continuity Min. Max.	Condenser No.	Capacity Microfarads
840-MI-25-7980A	12	1948	580047	580040	1.6	30 - 40	300153	.15-.205
940-MI-25-7980A	12	1949-50	580047	580040	1.6	30 - 40	300153	.15-.205
150-MI-25-7981A	12	1951	580120	580118	1.6	30 - 40	510173	.18-.22
250-MI-25-7981A	12	1952	580120	580118	1.6	30 - 40	510173	.18-.22
350-MI-25-7981B	12	1953	580120	580118	1.6	30 - 40	510173	.18-.22
450-MI-25-7982	12	1954	580153	580118	1.6	30 - 40	510173	.18-.22
550-MI-25-7982A	12	1955	580153	580118	1.6	30 - 40	510173	.18-.22

GAMBLE HIAWATHA

Year	Model No.	HP	Coil Number			Oper. Amp.	Prim. Res. Min. Max.	Sec. Cont. Min. Max.	Condenser No.		Capacity Microfarads
			Make	Mfg.	Scott				Mfg.	Scott	
1959	143A	7.5	Phelon	FG3689	138-134	2.5		40 - 60	FG3693	138-115	.15-.19
	148A	10	Phelon	FG3689	138-134	2.5		40 - 60	FG3693	138-115	.15-.19
	145A	25	McC		736-232	1.6		43 - 55	FG3478	1436-115	.18-.22
	345A	25	McC		736-232	1.6		43 - 55	FG3478	1436-115	.18-.22
	346A	40	McC		736-232	1.6		43 - 55	FG3478	1436-115	.18-.22
1960	A4BB	3.6	Phelon	FG3689	138-134	2.5		40 - 60	FG3693	138-115	.15-.19
	A4EB	7.5	McC		134-134	1.9		30 - 45	X12293	134-115	.18-.22
					234-134						
	C4EB	7.5	McC		134-134	1.9		30 - 45	X12293	134-115	.18-.22
					234-134						
	A4FB	12	Phelon	FG4128	139-134	2.5		40 - 60	FG3693	138-115	.15-.19
	A4GB	25	Wico	X11352	3685-113	2.0		40 - 60	X11362	3685-115	.26-.30
	C4GB	25	McC		436B-134	1.4		40 - 60	X12264	335B-115	.26-.30
	D4GB	25	McC		436B-134	1.4		40 - 60	X12264	335B-115	.26-.30
	C4HB	40	McC		336B-134	1.4		40 - 60	X12264	335B-115	.26-.30
1961	D4HB	40	McC		436B-134	1.4		40 - 60	X12264	335B-115	.26-.30
	C4JB	60	McC		C3JB-134	1.4	.55-.85	45 - 55	X12265	332B-115	.26-.30
	D4JB	60	McC		C3JB-134	1.4	.55-.85	45 - 55	X12264	332B-115	.26-.30
	61400310	3.6	Phelon	FG3689	138-134	2.5		40 - 60	FG3693	138-115	.15-.19

WESTERN AUTO WIZARD

Year	Model No.	HP	Coil Number		Oper. Amp.	Prim. Res. Min. Max.	Sec. Cont. Min. Max.	Condenser No.		Capacity Micro-farads
			Make	Mfg.				Scott	Mfg.	
1960	A7BB	3.6	Phelon	FG3689	2.5		40 - 60	FG3693	138-115	.15-.19
	A7EB	7.5	McC		1.9		30 - 45	X12293	134-115	.18-.22
	C7EB	7.5	McC		1.9		30 - 45	X12293	134-115	.18-.22
	A7FB	12	Phelon	FG4128	2.5		40 - 60	FG3693	138-115	.15-.19
	C7GB	25	Wico	X11352	2.0		40 - 60	X11362	3685-115	.26-.30
	D7GB	25	McC		1.4	.55-.85	40 - 60	X12264	335B-115	.26-.30
	C7HB	40	McC		1.4	.55-.85	40 - 60	X12264	335B-115	.26-.30
	D7HB	40	McC		1.4	.55-.85	40 - 60	X12264	335B-115	.26-.30
1961	C7JB	60	McC		1.4		45 - 60		332B-115	.25-.27
	D7JB	60	McC		1.4		45 - 60		332B-115	.25-.27
1961	61700310	3.6	Phelon	FG3689	2.5		40 - 60	FG3693	138-115	.15-.19
1961	61700710	7.5	McC		2.5		45 - 60	FG4477	A3EC-115	.15-.19
1962	62700310	3.6	Phelon	FG3689	2.5		40 - 60	FG3693	138-115	.15-.19
1962	62701410	14.1	Phelon	FG4128	2.0		40 - 60	FG3693	138-115	.15-.19

GOODRICH - "SEA FLYER"

Model No.	H.P.	Year	Magneto No.	Coil No.	Operating Amperage	Continuity Min. Max.	Condenser No.	Capacity Microfarads
45-050	3	1952	580128	580118	1.6	30 - 40	510173	.18-.22
64-180	5	1951	580120	580118	1.6	30 - 40	510173	.18-.22
45-060	5	1952	580120	580118	1.6	30 - 40	510173	.18-.22
45-070	12	1952	580120	580118	1.6	30 - 40	510173	.18-.22

AMC - "SABER"

Model No.	H. P.	Year	Magneto No.	Coil No.	Operating Amperage	Continuity Min. Max.	Condenser No.	Capacity Microfarad
3D12M	3	1955	580128	580118	1.6	30 - 40	510173	.18-.22
3D13M	3	1956	580128	580118	1.6	30 - 40	510173	.18-.22
5D11M	5	1955	580183	580118	1.6	30 - 40	510173	.18-.22
5S12M	5	1955-56	580120	580118	1.6	30 - 40	510173	.18-.22
5D12M	5	1956	580182	580118	1.6	30 - 40	510173	.18-.22
12D11M	12	1955	580153	580118	1.6	30 - 40	510173	.18-.22
12D13M	12	1956	580207	580118	1.6	30 - 40	510173	.18-.22
22D10M	22	1955	580180	580118	1.6	30 - 40	510173	.18-.22
22DE10M	22	1955	580180	580118	1.6	30 - 40	510173	.18-.22
22D11M	25	1956	580209	580118	1.6	30 - 40	510173	.18-.22
22D13M	25	1956	580209	580118	1.6	30 - 40	510173	.18-.22
22DE13M	25	1956	580209	580118	1.6	30 - 40	510173	.18-.22

FEDWAY - "SABER"

Model No.	H. P.	Year	Magneto No.	Coil No.	Operating Amperage	Continuity Min.-Max.	Condenser No.	Capacity Microfarads
3D10D	3	1953	580128	580118	1.6	30 - 40	510173	.18-.22
3D11D	3	1953	580128	580118	1.6	30 - 40	510173	.18-.22
5S10D	5	1953	580120	580118	1.6	30 - 40	510173	.18-.22
5D10D	5	1953	580120	580118	1.6	30 - 40	510173	.18-.22
12S10D	12	1953	580120	580118	1.6	30 - 40	510173	.18-.22
12D10D	12	1953	580120	580118	1.6	30 - 40	510173	.18-.22

WIZARD OUTBOARD MOTORS

Motor Model No.	H. P.	Year	Wico Coil No.	Operating Amp.	Coil Continuity Min.-Max.	Wico Cond. No.	Coil Ca Mf
170A	7.5	1959	FG3689	2.5	40 - 60	FG3693	.15 -
173A	7.5	1959	FG3689	2.5	40 - 60	FG3693	.15 -
175A	25	1959	FG3755	2.5	40 - 60	FG3478	.18 -
176A	25	1959	FG3755	2.5	40 - 60	FG3478	.18 -
376A	25	1959	FG3755	2.5	40 - 60	FG3478	.18 -

WISCONSIN MOTOR CORPORATION

Engine Model	Magneto Mfr.	Magneto No.	Coil No.	Operating Amperage	Continuity Min. Max.	Condenser No.	Microfarad Capacity
VR4D	F-M	X4A7B	R-2477C	1.70	40 - 60	AX-M-R2433	.18-.23
VG4D	F-M	XZE4B7	RS-2477C	1.70	40 - 60	MX2433X	.28-.35
	F-M	X4B7A	R-2477C	1.70	40 - 60	AX-M-R2433	.18-.23
	Wico	XH4	X5700	1.70	40 - 60	X5614	.16-.20
VP4D	F-M	ZV4B7	QS-2477C	1.65	40 - 65	SYX2433	.28-.33
	F-M	ZVE4B7	QS-2477C	1.65	40 - 65	EX2433	.17-.23
	Wico	XH4	X5700	1.70	40 - 60	X5614	.16-.20
	Wico	XHG4	X5700	1.70	40 - 60	X5614	.16-.20
VH4	F-M	X4B7A	R-2477C	1.50	40 - 60	AX-M-R2433	.18-.23
	F-M	XZE4B7	RS-2477C	1.70	40 - 60	MX2433X	.28-.35
	Wico	XH4	X5700	1.70	40 - 60	X5614	.16-.20
	F-M	ZV4B7	QS-2477C	1.65	40 - 65	SYX2433	.28-.33
	F-M	ZVE4B7	QS-2477C	1.65	40 - 65	EX2433	.17-.23
	F-M	XZE4B7	RS-2477C	1.70	40 - 60	MX2433X	.28-.35
	Wico	XH-20	X11600	1.90	40 - 60	X6916	.30-.34
	F-M	X1-2B7	Q2477C	1.70	50 - 70	X5614	.16-.20
	F-M	XE1-2B7C	Q2477C	1.70	50 - 70	X2433	.17-.23
	Wico	XH-2D	X11600	1.90	40 - 60	X2433	.17-.23
	F-M	X1-2B7	Q2477C	1.70	50 - 70	X6916	.30-.34
	F-M	XE1-2B7C	Q2477C	1.70	50 - 70	X5614	.16-.20
	Wico	XH1	X5700	1.70	40 - 60	X2433	.17-.23
	F-M	XD1B7S	X6762	2.50	50 - 60	X6916	.30-.34
	F-M	XD1B7U	S-2477C	1.70	50 - 60	X5614	.16-.20
	F-M		S-2477C	1.70	50 - 60	AX-M-R2433	.18-.23
						SYX-2433	.28-.33

WISCONSIN MOTOR CORPORATION (Cont'd)

Engine Model	Magneto Mfgr.	Magneto No.	Coil No.	Operating Amperage	Continuity Min. Max.	Condenser No.	Microfarad Capacity	
AENL	F-M	XDE1B7S	S-2477C	1.70	50 - 60	SYX-2433	.28-.33	
		XDE170	S-2477C	1.70	50 - 60	SYX-2433	.28-.33	
	Wico	XH1	X5700B	1.70	40 - 60	X6916	.30-.34	
	F-M	XD1B7S	S-2477C	1.70	50 - 60	AX-M-R2433	.18-.23	
	F-M	XD1B7U	S-2477C	1.70	50 - 60	AX-M-R2433	.18-.23	
	F-M	XDE1B7S	S-2477C	1.70	50 - 60	SYX2433	.28-.33	
	F-M	XE17U	S-2477C	1.70	50 - 60	SYX2433	.28-.33	
	Wico	XH1	X5700B	1.70	40 - 60	X6916	.30-.34	
	F-M	XD1B7R	T-2477C	1.90	40 - 60	AX-M-R2433	.18-.23	
	F-M	PE1B7R	T-2477C	1.90	40 - 60	SXY2433	.28-.33	
AGN	Wico	XH-1	X6762	2.50	40 - 60	X6916	.30-.34	
	Wico	XH-1	X5700	1.70	40 - 60	X5614	.16-.20	
	F-M	XE1A7F	S-2477C	1.90	45 - 65	AX-M-R2433	.18-.23	
	F-M	XD1B7	S-2477C	1.90	45 - 65	AX-M-R2433	.18-.23	
	F-M	X1A7	T-2477C	1.90	40 - 60	AX-M-R2433	.18-.23	
	F-M	XE1A7F	T2477C	1.90	40 - 60	AX-M-R2433	.18-.23	
	F-M	X1B7E	T-2477C	1.90	40 - 60	AX-M-R2433	.18-.23	
	Wico	XH1	X6762	2.50	40 - 60	X6916	.30-.34	
	Wico	XH1	X5700	1.70	40 - 60	X5614	.16-.20	
	F-M	XD1B7	S-2477C	1.90	45 - 65	R2433	.18-.23	
ADH & AE & AEH & AEHS	F-M	XDE1B7P	S-2477C	1.90	45 - 65	AX-M-R2433	.18-.23	
	F-M	X1A7	S-2477C	1.90	45 - 65	AX-M-R2433	.18-.23	
	F-M	XE1A7E	S-2477C	1.90	45 - 65	AX-M-R2433	.18-.23	
	F-M	X1B7E	S-2477C	1.90	45 - 65	AX-M-R2433	.18-.23	
	Wico	XH1	X6762	2.50	45 - 65	X6916	.30-.34	
	ACN & BKN	Wico	XH1	X6762	2.50	45 - 65	X5614	.16-.20

Engine Model	Magneto Mfgr.	Magneto No.	Coil No.	Operating Amperage	Continuity Min. Max.	Condenser No.	Microfarad Capacity
AA & AB & ABS & ABN & AK & AKS & AKN	F-M	XD1B7S	S-2477C	1.90	45 - 65	AX-M-R2433	.18-.23
	F-M	XD1B7U	S-2477C	1.90	45 - 65	AX-M-R2433	.18-.23
	F-M	XDE1B7S	S-2477C	1.90	45 - 65	SYX-2433	.28-.33
	F-M	XDE17U	S-2477C	1.90	45 - 65	SYX-2433	.28-.33
	Wico	XH1	X5700	1.70	40 - 60	X6916	.30-.34
	Wico	XH1	X6762	2.50		X5614	.16-.20
	F-M	XD1B7	H-2477C	1.90	45 - 65	R2433	.17-.23
	F-M	XD1B7D	H-2477C	1.90	45 - 65	R2433	.17-.23
	F-M	XDE1B7P	H-2477C	1.90	45 - 65	R2433	.17-.23
	F-M	X1A7	L-2477C	1.80	35 - 55	R2433	.17-.23
	F-M	X1A7E	L-2477C	1.80	35 - 55	R2433	.17-.23
	F-M	X1A7F	L-2477C	1.80	35 - 55	R2433	.17-.23
	F-M	XE1A7F	L-2477C	1.80	35 - 55	R2433	.17-.23
	F-M	J1A7	L-2477	1.80	35 - 55	M2433	.18-.22
MTHD	F-M	J1B7	L-2477	1.80	35 - 55	M2433	.18-.22
	Wico	XHS-2D	X7895	2.60		X7720	.16-.20
	F-M	PE1-2B7C	QT-2477C	1.70	40 - 65	LV-2433	.38-.43
	Wico	XHS-2D	X7895	2.60		X7720	.16-.20
	F-M	XVE4B7Q	H-2477	1.70	40 - 60	S2433	.28-.32
MVE4D & MVF4D TFM	F-M	ZVE4B7	QS-2477C	1.65	40 - 65	EX2433	.17-.23
	Wico	XH-2D	X6664	2.30		X6916	.30-.34
	F-M	JF2B7	G2477	1.55		X5614	.16-.20
ABM & AKM	F-M	X1A7E	H-2477C	1.90	40 - 65	M2433	.18-.22
	F-M	XD1B7D	H-2477C	1.90	40 - 65	R2433	.17-.23

WISCONSIN MOTOR CORPORATION (Cont'd)

Engine Model	Magneto Mfgr.	Magneto No.	Coil No.	Operating Amperage	Continuity Min. Max.	Condenser No.	Microfarad Capacity
AF & AG & AH	Wico	XH1	X5700	1.70	40 - 60	X6916	.30-.34
	Wico	XH1	X6762	2.50		X5614	.16-.20
AD-AE-AES	F-M	J1A7	L-2477	1.80	35 - 55	M2433	.18-.22
	Wico	XH-1	X5700	1.70	40 - 60	X6916	.30-.34
	Wico		X6762	2.50		X5614	.16-.20
	F-M	J1A7	L-2477	1.80	35 - 55	M2433	.16-.20
	F-M	X1A7	L-2477C	1.80	35 - 55	R-2433	.18-.22

D. W. ONAN & SONS COIL & CONDENSER SPECIFICATIONS

Model No.	Stator Assembly	Coil No.	Operating Amperage	Primary Resistance Min.-Max.	Secondary Continuity Min.-Max.	Condenser No.	Condenser Microfarads Min.-Max.
1C, 1B & AH, AJ, AK	160B305	160B155	2.7	.425 - .475	48 - 60	312A1	.18 - .22
CK(Prior to Spec. M)		160B86	.75	.07 - .11	55 - 65	312A19	.3 - .7
BH		160B99	.75	.07 - .11	55 - 65	312A19	.3 - .7
CK (Spec. M)		166B268	.75	.1 - .14	33 - 43	312A69	.28 - .32
K (Spec. M)	162A237	166B91	.75		32 - 44	312A19	.3 - .7
		166P259	.7	.2 - .25	54 - 65	312A100	.3 - .7
CCK	162A196	160C483	1.2	.07 - .1	54 - 65	312A69	.28 - .32

CLINTON MACHINE COMPANY

ENGINE DIVISION
COIL SPECIFICATIONS

Coil No.	Operating Amperage	Secondary Continuity Min. Max.	Coil No.	Operating Amperage	Secondary Continuity Min. Max.
P-5502	2.8	36 - 56	P-5563	2.2	50 - 70
P-5509	2.8	40 - 60	P-5593B	2.8	35 - 60
P-5531	2.8	40 - 60	P-5733	2.8	40 - 60
P-5538	2.8	36 - 60	P-5770	2.8	40 - 60
P-5545	2.8	36 - 60			

CONDENSER SPECIFICATIONS

Cond. No.	Capacity Mfd.	Cond. No.	Capacity Mfd.
P-2053	.12-.16	P-5599	.15-.19
P-3416	.15-.19	P-5736	.15-.19
P-5549	.22-.27	P-7219	.12-.16
P-5589	.15-.19		

CHAIN SAW & OUTBOARD DIVISION
COIL SPECIFICATIONS

Coil No.	Operating Amperage	Secondary Continuity Min. Max.	Coil No.	Operating Amperage	Secondary Continuity Min. Max.
P-513	2.8	40 - 60	P-700343	2.8	40 - 60
P-400467	2.8	40 - 60			
P-400789	2.8	40 - 60			

CONDENSER SPECIFICATIONS

Cond. No.	Capacity Mfd.	Cond. No.	Capacity Mfd.
P-261	.12-.16	P-700344	.12-.16
P-400777	.12-.16		

ECHLIN CONDENSER SPECIFICATIONS

Cond. No.	Capacity Mfd.	Cond. No.	Capacity Mfd.
13-200	.30-.36	29-200	.18-.22
13-201	.22-.25	29-201	.30-.36
13-202	.22-.25	37-200	.17-.21
13-203	.22-.25	37-201	.17-.21
13-204	.22-.25	73-200	.17-.21
13-205	.30-.36		
25-200	.18-.21		
25-201	.18-.22		

CONTINENTAL MOTORS
COIL SPECIFICATIONS

Coil No.	Manufacturer's No.	Operating Amperage	Continuity Min. Max.
AA7M3260 . . .	Smith	1.30	30 - 50
X6111	1.60	
AA7M2210 . . .	AA7M3260	1.30	30 - 50
X6718	1.80	
X7536	1.90	38 - 58
X7680	1.80	
FG-463B	2.80	40 - 60

CONTINENTAL MOTORS
CONDENSER SPECIFICATIONS

Condenser No.	Capacity Microfarads
AA7-M-2980225-.275

McCULLOCH
COIL SPECIFICATIONS

Coil No.	Operating Amperage	Primary Resistance Scale #2 Min. Max.	Secondary Continuity Min. Max.
19033C	2.421-.250	30 - 50
24033E	2.421-.250	30 - 50
51494	2.421-.250	30 - 50
51495	2.421-.250	30 - 50
55013	2.421-.250	20 - 40

McCULLOCH
CONDENSER SPECIFICATIONS

Condenser	Capacity Microfarads
All Models18-.22

KOHLER
COIL SPECIFICATIONS

Coil No.	Type	Operating Amperage	Continuity Min. Max.
S410	2 Cly. Flywheel	1.60

OLIVER OUTBOARD MOTORS
COIL SPECIFICATIONS

Coil No.	Operating Amperage	Secondary Continuity Min. Max.
10-94097	1.8	25 - 45
10-111287	1.8	38 - 58

OLIVER OUTBOARD MOTORS
CONDENSER SPECIFICATIONS

Condenser No.	Capacity Microfarads
10-8210413-.17
10-8860323-.27

PIONEER GEN-E-MOTOR
COIL SPECIFICATIONS

Coil No.	Operating Amperage	Secondary Continuity Min. Max.
60-1030	2.8	40 - 60
A60-084	2.8	40 - 60
C62-180	2.8	35 - 55

PIONEER GEN-E-MOTOR
CONDENSER SPECIFICATIONS

Condenser No.	Capacity Microfarads
60-08818-.22
60-106418-.22

AMERICAN BOSCH COIL SPECIFICATIONS

Coil No.	Type	Maximum Amperage
AA 63736	AB33-1922	1.45
AA 68936	AB34	1.55
AA 74709	ZR4 IS	1.45
AA 75795	AT4-AT4/2	1.05
AA 75798	DU4 ED 18 to 36	1.30
AA 75798	ZR4 ED 26	1.30
AA 76184	DU6 ED 18 to 26	1.10
AA 77815	U4 ED 1, 2, 3	.95
AA 77839	U2 ED 1	1.05
AA 78168	U1 ED 1	1.30
AA 81878	U4 ED 4	.95
CL 523	MJA ED B & C	1.30
CL 524	MJB ED A	1.30
CL 527	MJC4A & 6A	1.11
CL 528	MJC 1A & MJC 1B	1.17
CL 529	MJA (Special)	1.15
CL 5210	MJC6A	1.10
CL 5217	RF 41, 42 ED 1	1.85
CL 5220	MJA Heavy Duty	1.00
CL 5231	MJC4A, 6A, 4B, 6B	1.11
CL 5234	MVA2A, 2A310, 6A2108	1.40
CL 5236	MVA 1A, 1A310, 6A2108	1.40
CL 5238	MJC, ED C, 4C & 6C	1.30
CL 5239	MJHC	1.30
CL 5244	MJD	1.65
CL 5246	MVA ED A	1.40
CL 5249	MJC ED C	1.30
CL 5286	MJC ED C	1.30
CL 5293	MJH 2C	1.70
CL 5297	MJC ED C	1.30
CL 5298	MJK ED A & B	1.40
CL 52107	MJB ED B4 CYL	1.30
CL 52109	MJA ED D	1.30
CL 52118	MRA ED A	1.30
CL 52121	MJC ED C	1.30
CL 52127	MJC ED C	1.30
CL 52134	MJH ED C ALL TYPES	1.45
CL 52137	MRD	1.45
CL 52141	MJA ED D	1.30
CL 52143	MRD ED A	1.45
CL 52145	MRE ED A	1.40
CL 52164	MRA ED B	1.30
CL 52166	MRA ED B	1.30
CLC 6A5	LOW TEN., MAG. IGN., TRANS	.98
CLC 6A8	LOW TEN., MAG. IGN., TRANS	.98
CLC 6A8	LOW TEN., MAG. IGN., TRANS	.98
SA 75393	FY ED 2	2.00

AMERICAN BOSCH COIL SPECIFICATIONS (Cont'd)

Coil No.	Type	Maximum Amperage
SA 78081	FY 12 ED 2, 3, 4	2.05
SA 78308	FY 2, 6, 13, 17, 28, 36	2.20
SA 79555	FY 18 ED 1	1.80
SA 81426	FY 30 ED 1	1.30
SA 81603	FY 33 ED 1	2.00
SA 82995	S ED 1	.82
SA 83054	FY 37 ED 1	1.97
SA 84383	RF 17 ED 1	2.25
WC 2580	ZEV	1.50
WC 2594	AB 33-AB34-BA-AZ	1.45
WC 6040	AB34	1.45
WC 69342	FXI, 2, SPK-FBC 2 SPK	2.10
WC 73360	DU4 & 6-ZR 4 & 6	1.15
WC 74792	AT 4 & 6	1.05
WC 76104	FBC, FXI-FH-FB 1 & 2	1.50
WC 77803	U4 ED 1, 2, 3, FI	1.05
WC 79444	U6 ED 1	.98
WC 82913	SU 4, ED 1, 2, 3, 4	1.05
WC 82995	S ED 1	.82
WC 86187	U4 ED 2 (LOW SPEED)	1.00
WC 86188	U 4/2-U4, ED 2 and 4 (Low Speed)	1.00

J. I. CASE COMPANY COIL SPECIFICATIONS

20CMA	4JCMA	1.90
20JMA	4JMA	2.05

EDISON-SPLITDORF COIL SPECIFICATIONS

EX 4161	M1 & 2, AE2	1.70
EX 6178	R	1.35
EX 6406	RM4, RMG2	1.40
EX 6435	RM1, RM2	1.40
EX 6951	RMP-4 VAR	1.40
EX 6991	RM-2, RMP-2	1.40
EX 7746	C4, C6, CO	1.35
EX 23263	601, 700-702	2.00
EX 23579	235	1.45
EX 33740	GH1	1.00
EX 33795	GH2	1.00
EX 36034	All Dixie	1.90
EX 36161	648T	1.55
EX 50060	S1, 2, 4, SPO, SPI	1.10

AMERICAN BOSCH CONDENSER CAPACITIES SPECIFICATIONS

Part No.	Capacity Reading in Microfarads	
	Min.	Max.
CW522	.33	.39
CW5210	.33	.39
CW5224	.22	.27
CW5232	.22	.27
CW5249	.70	.85
CW5250	.22	.27
CW5252	.33	.39
CW5260	.22	.27
CW5263	.22	.27
CW5279	.22	.27
CW5291	.33	.39
CW5292	.28	.35
CW5293	.22	.27
CW5296	.33	.39
CW5297	.70	.85
CW5298	.33	.39
CW5299	.70	.85
CW52110	.28	.35
CW52131	.25	.28

American magneto coil specifications adapted for Merc-Tronic model #88 Magneto Ignition Analyzer.

Coil No.	Type	Operating Amperage	Continuity
			Min. - Max.
CL521	MJA (Special)	1.30	47 - 57
CL523	MJA Ed. B & C	1.30	47 - 57
CL524	MJB, Ed. A, MRF (variable timing)	1.30	52 - 62
CL527	MJC 4A & 6A	1.11	52 - 62
CL528	MJC 1A & MJC 1B	1.17	52 - 62
CL529	MJA (Special)	1.15	47 - 57
CL5210	MJC 6A	1.10	--
CL5217	RF 41, 42 ED. 1	1.85	--
CL5220	MJA, Heavy Duty	1.00	--
CL5231	MJC 4A, 6A, 4B, 6B	1.11	52 - 62
CL5234	MVA 2A, 2A 310, 6A 2108	1.40	52 - 62
CL5236	MVA 1A, 1A 310, 6A 2108	1.40	--
CL5238	MJC, Ed. C, 4C & 6C	1.30	52 - 62
CL5239	MJH 1C	1.30	--
CL5244	MJD	1.65	--
CL5246	MVA Ed. A	1.40	--
CL5249	MJC Ed. C	1.30	--
CL5286	MJC Ed. C	1.30	52 - 62
CL5293	MJH 2 C	1.70	--
CL5297	MJC ED. C	1.30	--

AMERICAN BOSCH CONDENSER CAPACITIES SPECIFICATIONS (Contd)

American magneto coil specifications adapted for Merc-Tronic model #88 Magneto Ignition Analyzer.

Coil No.	Type	Operating Amperage	Continuity
CL5298	MJK Ed. A & B	1.40	50 - 60
CL52107	MRF, MJB, ED. B, 4 cyl, (fixed timing)	1.30	52 - 62
CL52109	MJA Ed. D	1.30	47 - 57
CL52112	MJH	1.40	50 - 60
CL52115	MRD	1.30	52 - 62
CL52116	MJA	1.30	50 - 60
CL52117	MRD	1.45	48 - 58
CL52118	MRA, Ed. A	1.30	52 - 62
CL52119	MJH 4C	1.30	47 - 57
CL52121	MJC Ed. C	1.30	52 - 62
CL52127	MJC Ed. C	1.30	52 - 62
CL52134	MJH, MRD	1.45	48 - 58
CL52137	MRD	1.45	48 - 58
CL52141	MJA Ed. D	1.30	47 - 57
CL52143	MRD Ed. A	1.45	48 - 58
CL52145	MRE Ed. A	1.40	48 - 58
CL52158	MRB with CLC 6	1.70	Off scale.
CL52158	MRB with CLC 12	1.70	Off scale.
CL52158	MRB with CLT 40	2.20	Off scale.
CL52159	MRB with CLC 6	1.70	Off scale.
CL52159	MRB with CLC 12	1.70	Off scale.
CL52159	MRB with CLT 40	2.20	Off scale.
CL52162	MSB with CLC 6	1.5	Off scale.
CL52162	MSB with CLC 12	1.3	Off scale.
CL52162	MSB with CLT 40	1.9	Off scale.
CL52163	MJA with CLC 6	2.0	Off scale.
CL52163	MJA with CLC 12	2.0	Off scale.
CL52163	MJA with CLT 40	2.7	Off scale.
CL52164	MRA Ed. B, MJK	1.30	52 - 62
CL52165	MRA, MJA	1.30	52 - 62
CL52166	MRA	1.30	52 - 62
CL52167A	MRA	1.30	52 - 62
CL52168A	MRA	1.30	52 - 62
CL52172	MJB with CLC 6	1.7	Off scale.
CL52172	MJB with CLC 12	1.7	Off scale.
CL52172	MJB with CLT 40	2.2	Off scale.
CL52173	MRL with CLC 6	1.7	Off scale.
CL52173	MRL with CLC 12	1.7	Off scale.
CL52173	MRL with CLT 40	2.2	Off scale.
CL521001	MJF (Special)	1.30	52 - 62
CLC6A	Low tension mag. Ign. transformer	.98	
CLC6A 8	Low tension magn. Ign. transformer	.98	
CLC6A 8	Low tension mag. Ign. transformer	.98	

Coil No.	Type	Maximum Amperage
EX 50643	NS1	1.10
EX 51116	NS2, NS4	1.25
EX 51432	C2	1.10
EX 51446	CDH	1.20
EX 53315	K4	1.40
EX 60025	SSO	1.20
EX 60060	SS4-6	1.10
EX 62190	SS6-2 (Firing 2 Sparks)	1.50
EX 63585	B2, B3, B4, B6	1.20
EX 72080	AJ1	2.35
EX 72223	AJ2	2.35
EX 72288	AJ1 & 2	2.00

INTERNATIONAL HARVESTER COIL SPECIFICATIONS

E4329A	E4A-E4B-E4C	1.20
21401D	F4 (With Core)	2.10
21401D	F6 (With Core)	2.10
	H1-H4	2.10

ROBERT BOSCH COIL SPECIFICATIONS

WZ8164	DR2 spk.	1.50
ZA27279/7	Z4-Z6	1.30
ZA27279/8	ZR-ZU4, 6 Dual	1.20
ZA27279/9	P29h2-V1-V2	1.30
ZA27279/11	Z2 spk.	1.40
ZA27279/12	ZU-4, 6-ZR4, 6-2 spk.	1.20
ZA29035	ZR6-2	1.20
ZA29192	P22h2-V1-V2	1.30
ZA29244	P30h2-V1	1.60
ZA29362	DU4, 6, ZR4, 6 DR4	1.55
ZAK1/15	FF4, 6, FF4A, FF6A	1.75
ZAK1/16	FF1, 2-FFV	1.75
ZAK1/18	FF1A-FF2A-FFVA	1.75
ZAK2/11	FFC1-FFC1A-FFC1AR	1.30
ZAK4/11	FR4, 6-FR4A-FR4B	.95
ZAK10/11	FU4, 6-FU4A, FU4B, FU6B	1.25

EISEMANN FLYWHEEL MAGNETO COIL SPECIFICATIONS

COMPLETE STATOR COIL & CORE ASSEMBLY

Model Magneto	Principal User	Part No.	Amperage On		Part No.	Amperage On	
			Round Core	Square Core		Round Core	Square Core
51-A	Muncie	H23-495	----	1.90	H23-460	----	1.60
51-B	Sears	H23-499	----	1.90	H23-460	----	1.60
51-C	Sears	H23-454	----	1.90	H23-460	----	1.60
51-D	Sears	H23-538	----	1.90	H23-460	----	1.60
51-E	Clarke	H24-031	----	1.90	H23-460	----	1.60
51-F	Homelite	H24-701	----	1.90	H24-703	----	1.60
51-FS	Homelite	H26-662	----	1.90	H24-703	----	1.60
51-G	Sears	H24-833	----	1.90	H23-460	----	1.60
51-H	Sears	H24-831	----	1.90	H23-460	----	1.60
51-J	Muncie	H24-813	----	1.90	H23-460	----	1.60
51-K	Chic. Pneum.	H27-640	----	1.90	H23-460	----	1.60
51-KA	Gary Steel	H27-640	----	1.90	H23-460	----	1.60
51-M	Homelite	H27-349	----	1.90	H23-460	----	1.60
61-A	Lauson	H23-007	1.95	1.75	H23-010	1.70	1.50
	Latter Edition	H23-007	----	1.75	H24-820	----	1.50
61-B	Muncie	H23-034	2.00	1.80	H23-010	1.70	1.50
	Latter Edition	H23-034	----	1.75	H24-820	----	1.50
61-C	Sears	H23-072	2.00	1.80	H23-010	1.70	1.50
	Latter Edition	H23-072	----	1.75	H24-820	----	1.50
61-D, DA	Lauson	H23-231	----	1.75	-----	----	----
61-DAG	Lauson	H24-712	----	1.75	-----	----	----
61-DAL	Lauson	H24-239	----	1.75	-----	----	----
61-DC	Jacobsen	H23-231	----	1.75	-----	----	----
61-DD	Reo Motors	H23-231	----	1.75	-----	----	----
61-E	Champion	H24-023	1.95	1.75	H23-010	1.70	1.50
		-----	----	1.75	H24-820	----	1.50
61-F	Muncie	H24-793	----	1.75	H24-820	----	1.50

NOTE: Coils such as the H27-894 can only be tested in assembly with the laminated core or complete stator assembly.

EISEMANN FLYWHEEL MAGNETO COIL SPECIFICATIONS (Cont'd)

COMPLETE STATOR

COIL & CORE ASSEMBLY

Model Magneto	Principal User	Part No.	Amperage On		Part No.	Amperage On	
			Round Core	Square Core		Round Core	Square Core
61-G	Sears	H24-879	----	1.75	H24-820	----	1.50
61-GL	Sears	H24-801	----	1.75	H24-820	----	1.50
61-H	Mtgy.-Ward	H24-793	----	1.75	H24-820	----	1.50
61-J	Metal Prod.	H27-659	----	1.90	H26-034	----	1.60
61-K	Kiekhaefer	H24-838	----	1.75	H24-820	----	1.50
61-M	Scott-Atwater	H24-879	----	1.75	H24-820	----	1.50
62-A	Muncie	H26-028	----	1.90	H26-034	----	1.60
62-B	Metal Prod.	H27-645	----	1.90	H26-034	----	1.60
62-D	Lauson	H27-932	----	2.20	-----	----	-----
71-A	Muncie	H21-806	1.95	----	H21-808	1.75	----
71-AA	Muncie	H22-222	1.95	----	H21-808	1.75	----
71-B	Eisemann	H27-894	1.9	----	-----	----	----
71-C	Ideal	H21-851	1.95	----	H21-808	1.75	----
71-D	Wisconsin	H21-915	1.95	----	H21-808	1.75	----
71-E	Toro	H22-032	1.95	----	H21-808	1.75	----
71-F	Muncie	H21-938	1.95	----	H21-808	1.75	----
71-G	Toro	H21-984	1.25	----	H21-808	1.10	----
71-H	Cushman	H21-996	1.25	----	H21-967	1.10	----
71-I, M, O	Muncie	H22-375	1.25	----	H21-808	1.10	----
71-J	Cushman	H23-128	1.25	----	H21-808	1.10	----
71-K	Onan	H22-063	1.25	----	H21-808	1.10	----
71-L	Muncie	H22-142	1.25	----	H21-808	1.10	----
71-LE	Champion	H22-423	1.25	----	H21-808	1.10	----
71-M	Simplex	H23-181	1.25	----	H21-808	1.10	----
71-N	Lauson	H23-128	----	1.25	H21-808	----	1.10
71-O	Cushman	H23-150	1.25	----	H21-967	1.10	----
	Cushman	H23-128	----	1.25	H21-808	----	1.10

NOTE: Coils such as the H27-894 can only be tested in assembly with the laminated core or complete stator assembly.

EISEMANN FLYWHEEL MAGNETO COIL SPECIFICATIONS (Cont'd)

COMPLETE STATOR

COIL & CORE ASSEMBLY

Model Magneto	Principal User	Part No.	Amperage On		Part No.	Amperage On	
			Round Core	Square Core		Round Core	Square Core
71-P	Cushman	H23-218	1.25	---	H21-967	1.10	---
71-R	Lauson	H23-408	---	1.75	---	---	---
71-RL	Lauson	H24-230	---	1.75	---	---	---
71-RG	Lauson	H24-742	---	1.75	---	---	---
71-S-1-2-3	Nelson, Lauson, Mall Tool	H24-006	---	1.75	H24-004	---	1.50
71-T	Toro	H24-865	---	1.75	---	---	---
71-TA	Gladden Prod.	H24-865	---	1.75	---	---	---
72-A	Muncie	H23-046	2.00	---	H23-049	1.70	---
72-B	Champion	H23-114	2.00	---	H23-049	1.70	---
72-C	Sears	H23-106	2.00	---	H23-049	1.70	---
72-D	Maytag	H23-308	---	1.90	H23-330	---	1.60
72-DA	Maytag	H27-275	---	1.90	H27-277	---	1.60
72-E	Muncie	H24-842	---	1.75	H24-004	---	1.50
72-F	Muncie	H24-852	---	1.75	H24-856	---	1.50
72-H	Western Auto-Kiehaefer	H24-873	---	1.75	H24-004	---	1.50
72-J	Sears	H24-913	---	1.90	H24-929	---	1.60
82-D	Muncie	H21-824	1.75	---	H21-759	1.55	---
82-DA	Cross Gear	H21-882	1.75	---	H21-759	1.55	---
82-D, DA	Muncie	H21-824	---	1.75	H21-759	---	1.55
82-F	Muncie	H21-824	---	1.75	H21-759	---	1.55
	Eisemann	H27-894-L-P	1.9	---	---	---	---

NOTE: Coils such as the H27-894 can only be tested in assembly with the laminated core or complete stator assembly.

EISEMANN CONDENSER

Part No.	Capacity Microfarad
24235	.19 - .23

LAUSON POWER PRODUCTS COILS SPECIFICATIONS

Lauson Power Products Part No.	Manufacturer	Mfg. No.	Mounted Operating Amperage	Secondary Continuity Min. Max.
22094	Wico	X-2156	1.50	30 - 50
23084	Wico	X-4943	1.50	35 - 55
25527	Wico	X-7467	1.80	30 - 50
26714	Wico	X-8795	1.80	30 - 50
26935	Wico	X-8786	1.80	
27089	Wico	X-9055	2.10	35 - 55
27089	Wico	X-9695 RAP with X-11180	1.80	40 - 50
27376	Wico	X-11205	2.0	40 - 55
27531	Wico	X-9965	1.8	40 - 55
28259	Wico	X-11654	2.1	40 - 55
610355	Wico	X-8877	2.0	
610355	Wico	X-9767	1.80	35 - 55
610415	Wico	X-7500	2.10	30 - 50
610425	Wico	X-5345	1.50	40 - 60
24439	Phelon	FG-463	2.8	40 - 60
29176	Phelon	FG-3294	2.8	40 - 60
29176	Phelon	FG-4081	2.8	40 - 60
610242	Phelon	FG-114	2.5	40 - 60
610277	Phelon	FG-307	2.5	40 - 60
610286	Phelon	FG-420	2.8	40 - 60
610287	Phelon	FG-420B	2.8	40 - 60
610287	Phelon	FG-1573B	2.8	40 - 60
610292	Phelon	FG-470	2.8	40 - 60
610293	Phelon	FG-470B	2.8	40 - 60
610298	Phelon	FG-492B	2.5	40 - 60
610323	Phelon	FG-1309	2.8	40 - 60
610371	Phelon	FG-2180	2.8	40 - 60
610371	Phelon	FG-2446	2.8	40 - 60
610466	Phelon	FG-2641	2.8	40 - 60
610477	Phelon	FG-2180B	2.8	40 - 60
610482	Phelon	FG-2641B	2.8	40 - 60
610586	Phelon	FG-4055	2.8	50 - 70
25811	Fairbanks-Morse	A-2477A	1.60	
26318	Fairbanks-Morse	T-2477C	1.80	35 - 55
26624	Fairbanks-Morse	FX-2477	1.90	50 - 60
26787	Fairbanks-Morse	HX-2477	1.90	50 - 60
610215	Fairbanks-Morse	U-2477	1.70	50 - 60

LAUSON POWER PRODUCTS COILS SPECIFICATIONS

Lauson Power Products Part No.	Mfg.	Mfg. No.	Operating Amperage	Primary Resistance	Secondary Continuity Min.Max.
29632	Syncro	5022	2.3	.5 - 1.5	40 - 55

LAUSON POWER PRODUCTS CONDENSER SPECIFICATIONS

Lauson Power Products Part No.	Manufacturer	Mfgr. No.	Capacity Reading in Microfarads
22095	Wico	X-2186	.16-.20
23359	Wico	X-5800	.16-.20
26219	Wico	X-5614	.16-.20
26718	Wico	X-9100	.26-.30
27527	Wico	X-11000	.16-.23
29164	Wico	X-12174	.16-.20
29559	Wico	X-11672	.16-.20
29559	Wico	X-12513	.16-.20
610416	Wico	X-8959	.16-.20
610416	Wico	X-7461	.10-.15
610424	Wico	X-5342	.30-.34
610438	Wico	X-5463	.16-.20
24445	Phelon	FG-458	.12-.16
26641	Phelon	FG-458B	.12-.16
29172	Phelon	FG-4082	.15-.19
610253	Phelon	FG-159	.15-.19
610268	Phelon	FG-216	.15-.19
610269	Phelon	FG-216B	.15-.19
610294	Phelon	FG-471	.12-.16
610294	Phelon	FG-471B	.12-.16
610303	Phelon	FG-607	.15-.19
610303	Phelon	FG-1205	.35-.38
610331	Phelon	FG-1355	.12-.16
610370	Phelon	FG-2176	.15-.19
610370	Phelon	FG-2176	.15-.19
610467	Phelon	FG-2642	.12-.16
610588	Phelon	FG-4016	.18-.22
25809	Fairbanks-Morse	R-2433	.17-.23
26786	Fairbanks-Morse	GX-2433	.16-.19
610447	Fairbanks-Morse	BX-2433	.16-.19

MALLORY ELECTRIC CORPORATION COIL SPECIFICATIONS

Color Code & Coil No.	Operating Amperage	Primary Resistance	Ballist Resistance	Secondary Continuity Min. Max.
Green 6V-6000	.9	.4-.6	.3-.6	55 - 70
Blue 12V-12000	.9	1.1-1.4	.7-1.0	55 - 70
Black F-6	.9	.6-.8	.35-.6	55 - 65
Red F-12	.8	2.1-2.4	.7-.9	55 - 65
Black 12V-25828B	1.1	1.5-1.9	.35-.55	50 - 65
Red 25773	1.0	1.9-2.3		50 - 65
Brown 25742	1.25	.8-1.2		52 - 62

Color Code & Coil No.	Operating Amperate	Primary Resistance	Resistance Between P & R	Ballist Resistance	Secondary Continuity Min. Max.
MS6VP MS6VP	P-Side .4 R-Side .6	.5-.7 .4-.6	1.1-1.3	R-.45-.55 R-.45-.55	65 - 75
MS6VN MS6VN	P-Side .4 R-Side .6	.5-.7 .5-.7	1.1-1.3	P-.45-.55 R-.45-.55	
MS12VN MS12VN	P-Side .3 R-Side .5	1.5-1.8 .95-1.25	2.5-2.8	.9-1.2 .9-1.2	60 - 70
MS12VP MS12VP	P-Side .3 R-Side .5	2.0-3.5 1.0-3.0	4.0-5.0	.9-1.2 .9-1.2	

NOTE THIS TEST FOR MODEL 60 ONLY

MS6VP	2.9	65 - 75
MS6VN	2.5	65 - 75
MS12VN	1.9	65 - 75
MS12VP	1.9	65 - 75

MALLORY ELECTRIC CORPORATION CONDENSER
SPECIFICATIONS

Condenser Number	Capacity Reading in Microfarads
24125	.34-.38
24895	.34-.38
25010	.34-.38
25500	.26-.30
25600	.26-.30

AMERICAN BOSCH

Basic Condenser	Variation Condenser	Magneto	Capacity in Microfarads
CW527		MJC	.22 - .27
	CW5232	MJC	.22 - .27
	CW5279	MRD, MSA	.22 - .27
	CW5293	MRD	.22 - .27
	CW52131	MSB	.22 - .27
CW5210		MJA, MJB, MJF, MRA, MRF	.33 - .39
	CW5291	MJA, MJB, MJF, MRA, MRF	.33 - .39
	CW5296	MJA, MJB, MJF, MRF, MRA	.33 - .39
	CW5298	MJA, MJB, MJF, MRA, MRF	.33 - .39
CW5249		MRB	.70 - .85
CW5252		MJF	.33 - .39
CW52110		MJK	.28 - .35
	CW5292	MJK	.28 - .35
CW5297		MRB, MRL	.70 - .85

AUTO LITE

Part No.	Capacity in Microfarads	Part No.	Capacity in Microfarads
IAT 3076 Jr	.21 - .25	IBB 2042SS	.25 - .28
IAT 3076 LA	.25 - .28	IGB 1025, E, J.	.20 - .25
IBB 2015, L, R.	.25 - .28		

DELCO-REMY

Part No.	Capacity in Microfarads	Part No.	Capacity in Microfarads
1869704	.18 - .23	1882239	.29 - .34
1869705	.18 - .23	1900272	.18 - .23
1869706	.18 - .23	1928111	.18 - .23
1871678	.18 - .23	1932004	.18 - .23

FORD PRODUCTS

Part No.	Capacity in Microfarads	Part No.	Capacity in Microfarads
IGA-12300B	.29 - .32	7RA-123000	.21 - .25
8EL-12300A	.20 - .25	FAB-12300A	.21 - .25
H-12300	.30 - .34	B7A-12300A	.21 - .25
7RA-12300B	.21 - .25	B7A-12300B	.21 - .25



1962-1963 BULLETIN

NOTE: All spec. shown for Model 88 only can also be used for Model 98.

ROBERT BOSCH

Coil No.	Operating Amperage	Primary Resistance		Secondary Continuity
		Min.	Max.	Min. Max.
TK12A9	1.2	1.7	2.1	50 - 60
TK6A3	1.2	1.0	1.4	50 - 60
TK12A11	.7	2.8	3.3	45 - 55
TK6A11	1.2	1.0	1.4	45 - 55
TE6B3	1.3	.9	1.3	40 - 50
TK12A3	.75	3.0	3.6	50 - 60
TK6A7	1.2	1.0	1.4	45 - 55

BRIGGS & STRATTON

Coil No.	Operating Amperage	Secondary Continuity
		Min. Max.
297307	1.8	25 - 35

When Coil 297307 has special metallic shielded lead, Operating Amperage will increase to 2.4 amps.

BUNDY MARINE

Magneto Coil No.	Mfg. No.	Operating Amperage	Primary Resistance Min. Max.	Secondary Continuity Min. Max.
300-1535	TJ616	.75	3.3-3.7	55 - 65

Generator Coil No.	Resistance Reading Min. - Max.
300-15034-.55

Low Tension Coil No.	Resistance Reading Min. - Max.
300-1500	1.55-1.85

Diodes No.	Resistance Reading
300-1113	See page 24B for testing.

EISEMANN MAGNETOS COILS

Part No.	Model Used on or Type	Operating Amperage	Secondary Continuity Min. Max.
H27-958	All AM & LA models	1.35	40 - 60
H27-959	All models with H26-958 cam.	1.80	40 - 60
H28-030	RC & RT models	1.25	45 - 65
H27-940	All 51 series except 51F, & FS. 61J, 62A & B	1.9	35 - 55
H24-704	51F & FS	1.9	35 - 55
H27-927	62D	2.2	35 - 55
H27-894	All-61 series except 61J. & 61NA, 71R, RL, RG, S1, S2, S3, T, TA, 72E & H	1.75	35 - 55
H28-015	72A, B, C, (D, DA, & F.)	2.0	40 - 60
H28-015	72D & DA	1.9	40 - 60
H28-015	72F	1.75	40 - 60

EISEMANN MAGNETO CONDENSER

Part No.	Capacity Reading in Microfarads Min. - Max.
H22-910	.17-.22
H23-470	.17-.22
H24-235	.17-.22
H24-924	.17-.22
H26-982	.17-.22
H28-090	.17-.22

EVINRUDE MOTOR

Coil No.	Operating Amperage	Primary Resistance Min. Max.	Secondary Continuity Min. Max.
375189	1.9	.375-.575	30 - 45
378231 (75 HP)	0.9	1.65 -1.95	50 - 60
580243	1.7	.4 -.6	40 - 55
580416	1.7	.4 -.6	30 - 40

EVINRUDE CONDENSER SPECIFICATIONS

Condenser No.	Capacity Reading in Microfarads	Condenser No.	Capacity Reading in Microfarads
580321	.18-.22	580422	.25-.29
580256 (corrected)	.37-.41		

Resistance on Electromatic Evinrude Forward or Reverse Coils . . . 7.5 - 8.5 ohms.

JOHNSON MOTOR & OMC

Coil No.	Operating Amperage	Primary Resistance Min. Max.	Secondary Continuity Min. Max.
375189	1.9	.375-.575	30 - 45
378231 (75 HP)	0.9	1.65 - 1.95	50 - 60
580243	1.7	.4 - .6	40 - 55
580416	1.7	.4 - .6	30 - 40

JOHNSON & OMC CONDENSER SPECIFICATIONS

Condenser No.	Capacity Reading in Microfarads	Condenser No.	Capacity Reading in Microfarads
580321	.18-.22	580422	.25-.29
580256 (corrected)	.37-.41		

Resistance on Electromatic Johnson Forward or Reverse Coils . . . 7.5 - 8.5 ohms.

THE FOLLOWING TEST ON MODEL 88 ONLY
KIEKHAEFER-MERCURY COIL SPECIFICATIONS

Kiekhauer Part No.	Mfgr. & No.	Operating Amperage	Primary Resistance Min. Max.	Secondary Continuity Min. Max.
32193	Autolite - 200673	1.1	1.2-1.4	60 - 70
32704	(Note: With Internal Resistance)	0.5	3.9-4.3	48 - 58

KIEKHAEFER-MERCURY RESISTOR TEST

Mfgr. & Part No.	Mfgr. & Part No.	Resistance Reading Min. - Max.
Kiekhauer - 32227	Autolite - 200673	.410-.520

LAUSON POWER PRODUCTS
COIL SPECIFICATIONS

Lauson Power Product Part No.	Syncro No.	Operating Amperage	Primary Resistance Min. Max.	Secondary Continuity Min. Max.
30560	5160	2.9	.35-.45	40 - 55
30546		2.0		42 - 52

KOHLER CO.
COIL AND CONDENSER SPECIFICATIONS

Kohler No.	Mfg. and No.	Operating Amperage	Secondary Continuity Min. Max.
K91-Eng.			
Coil-220435	Phelon FG2145	2.8	40 - 60
Cond-220434	Phelon FG2138	Cond. Capacity in Mfd.	.12-.16
K161-Eng.			
Coil-230075	Scintilla 10-160396	1.8	30 - 40
Cond-230082	Scintilla 10-79168Y	Cond. Capacity in Mfd.	.27-.31
K241 and K331-Eng.			
Coil-275756	Phelon FG1641	2.2	40 - 60
Cond-220434	Phelon FG2138	Cond. Capacity in Mfd.	.12-.16
K662-Eng.			
Coil-270560	Wico X12810	1.7	60 - 75
Coil-271144	Wico X5700C	1.7	40 - 60
Coil-270775	Fairbanks Q3477C	1.7	50 - 70
Cond-270779	Fairbanks SYX2433X	Cond. Capacity in Mfd.	.28-.36
Cond-270541	Wico X6916	Cond. Capacity in Mfd.	.30-.34
Cond-270607	Wico X5614	Cond. Capacity in Mfd.	.16-.20

LAWN BOY COIL SPECIFICATIONS

LAWN BOY CONDENSER SPECIFICATIONS

Coil No.	Operating Amperage	Continuity Min. Max.	Condenser No.	Capacity Microfarads
580-118	1.60	30 - 40	510173	.13 - .17
580-184	1.60	30 - 40	677299	.13 - .17

McCULLOCH COIL SPECIFICATIONS
CHAIN SAW

Coil No.	Operating Amperage	Primary Resistance Min. Max.	Secondary Continuity Min. Max.
55949	1.9	.5-.58	45 - 60

R. E. PHELON MAGNETO COILS

Coil No.	Operating Amperage	Secondary Continuity Min. Max.
FG6001	2.5	40 - 60

R. E. PHELON
CONDENSER SPECIFICATIONS

Condenser No.	Capacity Microfarads
FG447715-.19

PIONEER GEN-E-MOTOR
COIL SPECIFICATIONS

Coil No.	Operating Amperage	Secondary Continuity Min. Max.
60-1445	2.3	40 - 55

WICO IGNITION
MAGNETO COIL SPECIFICATION

Coil No.	Operating Amperage	Primary Resistance Min.-Max.	Secondary Continuity Min.-Max.
X4658B Rep. X7453			
X11600 (Replaces X6664 & X8964) ..	1.9	40 - 60
X12660	1.8	40 - 55
X12609	1.8	.35-.5	45 - 60
X12810	1.7	.5-.7	60 - 75
X12905	1.8	.4-.6	50 - 60
X12915	1.8	.4-.6	50 - 60
X30089B	1.1	1.1-1.3	40 - 55
X13313	1.8	40 - 55
X13665	1.8	50 - 60
X12609	1.6	.35-.5	45 - 60
X12810	1.6	.5-.7	60 - 75

WICO IGNITION CONDENSER SPECIFICATION

Cond. No.	Capacity Reading In Microfarads	Cond. No.	Capacity Reading In Microfarads
X11818	.58-.62	X30028	.18-.23
X12303	.16-.20	X30188	.30-.34
X12508	.16-.20	X30280	.26-.30
X12647	.26-.30	X30280B	.26-.30
X13299	.16-.20		

FAIRBANKS-MORSE CONDENSER SPECIFICATIONS

Part No.	Capacity Reading in Microfarads	
	Min.	Max.
KX2433	.28	.35
PX2433	.28	.35
QX2433	.28	.35
RX2433	.37	.42
SYX2433X	.28	.36
TX2433	.28	.35
WX2433	.28	.35

GALE PRODUCTS-OMC COIL SPECIFICATIONS

Coil No.	Operating Amperage	Primary Resistance		Secondary Continuity
		Min.	Max.	
425371	1.9			38 - 58
425960	2.10			30 - 50
470187-①	1.8			40 - 55
470187-②	1.7			50 - 60
470685-③	1.4	.5	.7	40 - 55
470685-④	1.8	.47	.55	30 - 40
580454	1.4	.4	.6	30 - 40

CONDENSER SPECIFICATIONS

Condenser No.	Capacity Microfarads	
	Min.	Max.
425369	.16	.20
425373	.16	.20
425702	.16	.20
426528	.18	.22

KIEKHAEFER-MERCURY OUTBOARD COIL SPECIFICATIONS

Kiekhaefer Part No.	Mfgr. & No.	Operating Amperage	Primary Resistance		Secondary Continuity
			Min.	Max.	
398-2201	Phelon - FG-6446	2.0	.45	.60	45 - 60
394-1128A1	Kiekhaefer - 394-1128	1.80*			55 - 65

*Off Plate

KIEKHAEFER-MERCURY OUTBOARD CONDENSER TEST SPECIFICATIONS

Kiekhaefer Part No.	Manufacturer	Mfgr. No.	Capacity Reading in Microfarads
398-2203	Phelon	FG-6453	.14 - .20

KIEKHAEFER-MERCURY RESISTOR TEST

Mfgr. & Part No.	Resistance Reading Min. - Max.
Keikhaefer - 393-1286	1.3 - 1.7
Keikhaefer - 393-1482	2.0 - 2.4
Keikhaefer - 393-1572	3.0 - 3.4

KOHLER CO. COILS SPECIFICATIONS

Coil No.	Mfgr. & No.	Operating Amperage	Secondary Continuity Min. Max.
270775	Fairbanks Morse-Q2477CX	1.70	50 - 70

KOHLER CO. CONDENSERS SPECIFICATIONS

Kohler No.	Mfg. and No.	Cond. Capacity in Mfd.
230722	Delco-Remy 194948	.18 - .23

LAUSON-POWER PRODUCTS COIL SPECIFICATIONS

Lauson Power Products Part No.	Mfg.	Mfg. No.	Operating Amperage	Secondary Continuity Min. Max.
610657	Phelon	FG6335	2.8	40 - 60

LAUSON-POWER PRODUCTS CONDENSER SPECIFICATIONS

Part No.	Capacity Mfd.
29164	.16 - .20
30548	.12 - .14



1964 BULLETIN

NOTE: All spec. shown for Model 88 only can also be used for Model 98.

AMERICAN BOSCH COIL SPECIFICATIONS

Coil No.	Operating Amperage	Primary Resistance Min. Max.	Secondary Continuity Min. Max.
CL521005A	1.5	.4 - .5	50 - 60
CLT10A1S	.8	10 - 12	45 - 55
CLC12A5S	.7	3 - 4	45 - 55

EVINRUDE JOHNSON MOTORS COIL SPECIFICATIONS

Coil No.	Operating Amperage	Primary Resistance Min. Max.	Secondary Continuity Min. Max.
378231	.8	1.65 - 1.85	55 - 65
379569	.7	1.65 - 1.85	70 - 80
580380	.9	.7 - .9	65 - 75
580527	.7	.7 - .9	65 - 75

When testing above coil #580527 with yoke add an additional 3 to 4 volts in series with present battery, or total of 10.5 to 11 volts. This is necessary due to the large yoke attached. Use the additional voltage for coil power test only pertaining to this coil #580527.

Do not attempt to make any other tests on this voltage.

75 and 90 HORSE POWER EVINRUDE-JOHNSON OUTBOARDS

Coil No.	Operating Amperage	Primary Resistance Min. Max.	Secondary Continuity Min. Max.
378231	.8	1.65 - 1.85	55 - 65
379569	.7	1.65 - 1.85	70 - 80

NOTE: Johnson outboard condenser #580243 on page 37, in Manual Of Operation And Specifications should read 580256.

CAPACITY: Minimum .37 - Maximum .41

Coil No.	Operating Amperage	Primary Resistance		Secondary Continuity	
		Min.	Max.	Min.	Max.
378231	.8	1.65	1.85	55	65
379569	.7	1.65	1.85	70	80

OMC INDUSTRIAL 1 CYLINDER 9 HORSE POWER ALUMINUM ENGINE

Coil No.	Operating Amperage	Primary Resistance		Secondary Continuity	
		Min.	Max.	Min.	Max.
378231	.8	1.65	1.85	55	65

OMC INDUSTRIAL 2 CYLINDER 18 HORSE POWER ALUMINUM ENGINE

Coil No.	Operating Amperage	Primary Resistance		Secondary Continuity	
		Min.	Max.	Min.	Max.
580380	.9	.7	.9	65	75
580527	.7	.7	.9	65	75

NOTE: See Page 1, 1964 Bulletin under heading "Evinrude-Johnson" for testing coil 580527
CONDENSER SPECIFICATIONS

Engine Model	Condenser #	Sleeve Color	Capacity MFD
Magneto 9 HP Single	510478	Red	.33 - .41
Battery Ignition 9 HP Single	510613	Green	.18 - .22
Battery Ignition 18 Twin	510478	Red	.34 - .41
Magneto Automatic Advance 18 Twin	510615	Green	.18 - .22
Magneto Automatic Advance 9 Single	510613	Green	.18 - .22

OMC PIONEER CHAIN SAW COIL SPECIFICATION

Coil No.	Operating Amperage	Primary Resistance		Secondary Continuity	
		Min.	Max.	Min.	Max.
470685- (4)	1.8	.47	.55	30	40

FAIRBANKS-MORSE COIL SPECIFICATIONS

Coil No.	Operating Amperage	Primary Resistance		Secondary Continuity	
		Min.	Max.	Min.	Max.
GX2477C	1.70			40	60
QP2477C	1.70			50	70
QR2477C	1.70			50	70
QW2477C	1.70			50	70
QX2477C	1.70			50	70
QZ2477C	1.70			50	70
Q2477CX	1.70			50	70
TX2477	1.5	.62	.68	45	55
X2477	1.5	.62	.68	45	55

1964 McCULLOCH CORP. OUTBOARD MOTOR SPECIFICATIONS

Model No.	H.P.	Make	COIL NUMBER		Oper. Amp.	Primary Resistance		Secondary Continuity		CONDENSER NO.		Capacity Microfarad Min.-Max.
			Mfg.	Scott		Min.-Max.	Min.-Max.	Min.-Max.	Mfg.	Scott		
64300310	3.5	Phelon	FG3689	1380134	2.5		45 - 60	FG3693	1380115	.15 - .19		
64300410	3.5	Phelon	FG3689	1380134	2.5		45 - 60	FG3693	1380115	.15 - .19		
64300710	7.5	Phelon	FG6001	76088	2.5		45 - 60	FG4477	76065	.15 - .19		
64300750	7.5	Phelon	FG6001	76088	2.5		45 - 60	FG4477	76065	.15 - .19		
64301410	14	Phelon	FG4128	1390134	2.5		40 - 55	FG3693	1380115	.15 - .19		
14000200	14	Phelon	FG4128	1390134	2.5		40 - 55	FG3693	1380115	.15 - .19		
64302810	28	Wico	X11135	36850113	2.0		45 - 60	X11362	36850115	.26 - .30		
64302830	28	McCul		TOP CYL 76089	1.4		45 - 60	X11264	76067	.26 - .30		
				BOTTOM 76092	1.4		45 - 60	X11264	76067	.26 - .30		
64304510	45	Wico	X11352	36850113	2.0		45 - 60	X11362	36850115	.26 - .30		
64304520	45	Wico	X11352	36850113	2.0		45 - 60	X11362	36850115	.26 - .30		
64304530	45	Andover		71230A	1.1	1.0 - 1.4	60 - 70	X11264	76067	.26 - .30		
64304540	45	Andover		71230A	1.1	1.0 - 1.4	60 - 70	X11264	76067	.26 - .30		
	45			7387-5	1.0	1.1 - 1.4	55 - 65	X11264	76067	.26 - .30		
64307530	75	Andover		75455	1.0	1.0 - 1.4	60 - 70	X11264	76066	.25 - .27		
64307543	75	Andover		75455	1.0	1.0 - 1.4	60 - 70	X11264	76066	.25 - .27		
	75			79670	.85	1.02 - 1.42	55 - 65		76066A	.18 - .22		

McCULLOCH CORPORATION CHAIN SAW COIL

Coil No.	Operating Amperage	Primary Resistance		Secondary Continuity	
		Min.	Max.	Min.	Max.
C4	1.5	.49	.55	45	55

R. E. PHELON MAGNETO COILS SPECIFICATIONS

Coil No.	Operating Amperage	Continuity	
		Min.	Max.
FG-3502	2.8	45	60
FG-3755X	2.5	45	60
FG-3773	2.8	45	60
FG-3872	2.8	45	60
FG-4448	2.8	45	60
FG-6235	2.8	55	70
FG-6240	2.7	50	65
FG-6388	2.8	45	60
FG-6446	2.6	45	61
FG-6547	1.7	60	76

R. E. PHELON CONDENSER SPECIFICATIONS

Part No.	Capacity Mfd.
FG-4312	.24 - .28
FG-4449	.15 - .19
FG-6048	.15 - .19
FG-6168	.15 - .19
FG-6170	.15 - .19
FG-6225	.11 - .15
FG-6453 - 6470	.15 - .19
FG-6548	.24 - .28
FG-6867	.12 - .16

RONCO CORPORATION COIL SPECIFICATIONS

Coil No.	Operating Amperage	Primary Resistance		Secondary Continuity	
		Min.	Max.	Min.	Max.
1111	1.25	.35	.45	45	50

Full power amperage approximately 2.6

SEA KING MOTORS

Model	Coil No.	Operating Amperage	Primary Resistance	Secondary Continuity		Condenser No.	Capacity Microfarads	
				Min.	Max.		Min.	Max.
19068	X12940	1.4	.4 - .6	50 - 60		X12174	.16 - .20	
19072	X11406	2.1		40 - 60		X11397	.16 - .20	
19076	X11406	2.1		40 - 60		X11397	.16 - .20	
19084	X14381	1.4	.4 - .6	50 - 60		X12303	.16 - .20	
19088-								
19089	LX2477	1.5		40 - 60		S2433	.28 - .36	
19088A-								
19089A	TX2477	1.5	.62 - .68	45 - 55		S2433	.28 - .36	
19092-								
19093	X11563	0.75		40 - 60		X11337	.26 - .30	
19096	X11563	0.75		40 - 60		X12647	.26 - .30	

WEST BEND MOTORS

Model	Coil No.	Operating Amperage	Primary Resistance	Secondary Continuity		Condenser No.	Capacity Microfarads	
				Min.	Max.		Min.	Max.
3401	X12660	1.8		40 - 55		X12174	.16 - .20	
6401	X11406	2.1		40 - 60		X11397	.16 - .20	
10401-								
10403	X11406	2.1		40 - 60		X11397	.16 - .20	
20401	X14381	1.4	.4 - .6	50 - 60		X12303	.16 - .20	
35401-								
35431	TX2477	1.5	.62 - .68	45 - 55		S2433	.28 - .36	
45421-								
45431								
45423-								
45433	TX2477	1.5	.62 - .68	45 - 55		S2433	.28 - .36	
50421-								
50431	TX2477	1.5	.62 - .68	45 - 55		S2433	.28 - .36	
50461-								
50471	X11563	0.75		40 - 60		X11337	.26 - .30	
80461-								
80471	X11563	0.75		40 - 60		X12647	.26 - .30	
80242-								
80252	X11563	0.75		40 - 60		X12647	.26 - .30	
9501	X11406	2.1		40 - 60		X11397	.16 - .20	

WICO COIL SPECIFICATIONS

Coils No.	Operating Amperage	Primary Resistance		Secondary Continuity	
		Min.	Max.	Min.	Max.
X12910	1.8	.4	.6	50	60
X12920	1.8	.4	.6	50	60
X12925	1.8	.4	.6	50	60
X12930	1.8	.4	.6	50	60
X12935	1.8	.4	.6	50	60
X12940	1.4	.4	.6	50	60
X13000	1.5	.45	.65	50	60
X13655	1.8	.4	.6	50	60
X14171	1.3	.6	.7	50	60
X14276	1.4	.4	.6	50	60
X14381	1.4	.4	.6	50	60
X14501	1.4	.4	.6	50	60

WICO CONDENSER SPECIFICATIONS

Cond. No.	Capacity Reading In Microfarads
X11206	.30 - .34
X11264	.26 - .30
X12302	.16 - .20
X12984	.30 - .34
X14497	.16 - .20
X14590	.24 - .28



1966 BULLETIN

SUPPLEMENTARY SPECIFICATIONS COVERING YEARS 1965-67

AUTOLITE IGNITION COIL

Coil No.	Type	Operating Amperage	Primary Resistance		Secondary Continuity		Condenser No.	Capacity Microfarads	
			Min.	Max.	Min.	Max.		Min.	Max.
200673		1.1	1.1	1.5	60	70			
710108		1.1	1.2	1.4	60	70			

AUTOLITE BALLAST

201010	Resistance	Min. .410	Max. .520
200673	Resistance	Min. .410	Max. .520

BRIGG & STRATTON

Model No.	Coil No.	Operating Amperage	Primary Resistance		Secondary Continuity	
			Min.	Max.	Min.	Max.
100200	298316	1.8	.18	.24	25	35
100900						
60000	298502	1.8	.18	.24	25	35
80000						
60000	298654	1.8	.18	.24	25	35
80000						
243000	298968	1.6	.18	.24	40	50
144000	298968	1.6	.18	.24	40	50
145000	298968	1.6	.18	.24	40	50
146000	298968	1.6	.18	.24	40	50
147000	298968	1.6	.18	.24	40	50
193000	298968	1.6	.18	.24	40	50
233000	298968	1.6	.18	.24	40	50

BRITISH SEAGULL

Coil No.	Operating Amperage	Primary Resistance		Secondary Continuity		Condenser No.	Capacity Microfarads	
		Min.	Max.	Min.	Max.		Min.	Max.
AM1634E	2.0	.28	.32	30	40	Villiers	.20	.26

BRIDGESTONE BY ROCKFORD MOTORS INC.

Model No.	Mfgr.	Coil No.	Type	Oper. Amps	Primary Resistance		Secondary Continuity		Capacity	
					Min.	Max.	Min.	Max.	Min.	Max.
BS-HM/S 50 Leader	Rockford	GA1-17211 E19221	Ignition Lighting	1.5	1.0-1.2	.05	35 - 45	E19241	.25 - .30	
BS-7S Sportster Std.	Rockford	GA1-17211 E19221	Ignition Lighting	1.5	1.0-1.2	.05	35 - 45	E19241	.25 - .30	
BS-7D Sportster Del.	Rockford	E09301	Ignition	.6	5.4-6.7		50 - 60	E09105	.25 - .30	
BS-90	Rockford	EA1-89310	Ignition	.7	2.0-2.5		55 - 65	EA1-17241	.25 - .30	
BS-90T										
BS-90M										
BS-90 Sport.										
BS-90		EA1-17212	Ignition Primary		.6-.7					
BS-90T										
BS-90M										
BS-90 Sport.	Rockford	EA1-17213	Lighting		.5					
BS-50S	Rockford	EA1-38310	Ignition	.7	2.0-2.5		55 - 65	EA1-17241	.25-.30	
BS-60S										
Sport.										
BS-50S		GB1-17212	Ignition Pri.		.6-.7					
BS-60S	Rockford	GB2-17213	Lighting		.1-.14					
BS-175DT	Rockford	8501-8000	Ignition (2)	.8	4.2-5.2		60 - 70	1753-8000	.25-.30	

NOTE: To test above coils, disconnect the internal 7-1/2 volt battery and connect leads to a 12 volt storage battery or equal. Connect our part #47-174 suppressor in series with one test lead. Caution: Do not use the 12 volts for any other tests as all other things will be incorrect.

Model No.	H.P.	Coil No.	Oper. Amps	Primary Resistance		Secondary Continuity		Condenser No.	Capacity Microfarads	
				Min.	Max.	Min.	Max.		Min.	Max.
360	3.5	X12940	1.5	.45-	.65	50	- 60	X12174	.16	-.20
361	3.5	X12940	1.5	.45-	.65	50	- 60	X12174	.16	-.20
660	6.0	X14877	1.4	.4	-.6	50	- 60	X11397	.16	-.20
960	9.2	X14877	1.4	.4	-.6	50	- 60	X11397	.16	-.20
964	9.2	X14877	1.4	.4	-.6	50	- 60	X11397	.16	-.20
2060	20.0	X14381	1.4	.4	-.6	50	- 60	X12303	.16	-.20
2061	20.0	X14381	1.4	.4	-.6	50	- 60	X12303	.16	-.20
2064	20.0	X14381	1.4	.4	-.6	50	- 60	X12303	.16	-.20
3560	35.0	TX2477	1.5	.62-	.68	45	- 55	S2433	.28	-.32
3563	35.0	TX2477	1.5	.62-	.68	45	- 55	S2433	.28	-.32
4562	45.0	TX2477	1.5	.62-	.68	45	- 55	T12042	.30	-.33
4563	45.0	TX2477	1.5	.62-	.68	45	- 55	T12042	.30	-.33
5062	50.0	TX2477	1.5	.62-	.68	45	- 55	X11337	.26	-.30
5063	50.0	TX2477	1.5	.62-	.68	45	- 55	X11337	.26	-.30
5066	50.0	TX2477	1.5	.62-	.68	45	- 55	S2433	.28	-.33
5067	50.0	TX2477	1.5	.62-	.68	45	- 55	S2433	.28	-.33
7566	75.0	A85475-1*12V	1.0	1.7-	2.3	65	- 75	14022	.38	-.40
7567	75.0	A85475-1*12V	1.0	1.7-	2.3	65	- 75	14022	.38	-.40
10566	105.0	A85475-1*12V	1.0	1.7-	2.3	65	- 75	14022	.38	-.40
10567	105.0	A85475-1*12V	1.0	1.7-	2.3	65	- 75	14022	.38	-.40
Corrections for pages 59, 60A,B and C		A91475-1*12V	1.0	3.0-	3.6	50	- 60			
		X11563 *12V	.75	1.1-	1.7	50	- 60			

NOTE: To test Coil (*12V) disconnect the internal battery and connect leads to a 12 volt storage battery. Do not use the 12 volts for any other tests as all other reading will be incorrect.

CUSHMAN MOTORS

Coil No.	Operating Amperage	Primary Resistance		Secondary Continuity		Condenser No.	Capacity Microfarads	
		Min.	Max.	Min.	Max.		Min.	Max.
580346	1.5	.4	-.6	40	- 50	510478	.33	-.41
580380	1.0	.6	-.8	70	- 80	510613	.18	-.22
580600	.75	.9	- 1.5	60	- 70			

DELCO-REMY IGNITION COIL

Coil No.	Type	Operating Amperage	Primary Resistance		Secondary Continuity		Condenser No.	Capacity Microfarads	
			Min.	Max.	Min.	Max.		Min.	Max.
1115153	Battery	.9	1.65	1.95	50	60	194948	.18	.23
1115032		.5	3.9	4.3	48	58			
1115106		.9			55	65			

EATON - VOLVO 110 AQUAMATIC

Coil No.	Operating Amperage	Primary Resistance		Secondary Continuity		Condenser No.	Capacity Microfarads	
		Min.	Max.	Min.	Max.		Min.	Max.
TK12A3	.6	3.2	3.6	50	60	238852	.21	.28
200691	.57	3.5	3.9	55	65			
1000281								
6024								
200692 (Prestolite)	.7	1.1	1.5	55	65			
1000193								
(Eaton)								

<u>Resistor No.</u>	<u>Resistance Min. Max.</u>
201016	.49 - .55

Year - 1962

ELGIN MOTORS

Elgin No.	Model No.	H.P.	Mfg.	Coil No.	Elgin No.	Oper. Amps	Primary Resistance Min. Max.	Secondary Resistance Min. Max.	Condenser Mfg. No.	Elgin No.	Primary Resistance Min. Max.
574-60020	62600310	3.6	Phelon	FG3689	1380134	2.5		40-60	Phelon FG3693	1380115	.15-.19
574-60051	62600610	6.0	Phelon	FG6001	76088	2.5		45-60	Phelon FG4477	76065	.15-.19
574-60081	62600710										
574-60131	62601410	14.1	Phelon	FG4128	1390134	2.5		40-55	Phelon FG3693	1380115	.15-.19
574-60331	62602810	27.7	Wico	X11135	36850113	2.0		45-60	Wico X11362	36850115	.26-.30
574-60351	62602820	27.7	Wico	X11135	36850113	2.0		45-60			
574-60332	62602830	27.7	Wico	X11135	36850113	2.0		45-60	Wico X11362	36850115	.26-.30
574-60352	62602830	27.7	Wico	X11135	36850113	2.0		45-60	Wico X11362	36850115	.26-.30
574-60333	62602840	27.7	Wico	X11135	36850113	2.0		45-60	Wico X11362	36850115	.26-.30
574-60353	62602840	27.7	Wico	X11135	36850113	2.0		45-60	Wico X11362	36850115	.26-.30
574-60522	62604432	40.0	McCul	Top	76089	1.4	.55-.85	45-60	Wico X11264	76067	.26-.30
574-60532	62604442	40.0	McCul	Bottom	76092	1.4	.55-.85	45-60	Wico X11264	76067	.26-.30
574-60520	62604430	43.7									
574-60530	62604440										
574-61521	62604431	43.7	Wico	X11135	36850113	2.0		45-60	Wico X11362	36850115	.26-.30
574-61531	62604441										
574-60720	62607523	75.0	McCul		76091	1.10	.6-.9	45-55		76066A	.25-.27
574-60730	62607540										
Year - 1963											
574-60021	63600311	3.5	Phelon	FG3689	1380134	2.5		40-60	Phelon FG3693	13800115	.15-.19
574-60090	63600711	7.5	Phelon	FG6001	7688	2.5		45-60	Phelon FG4477	76065	.15-.19
574-60091	63600712	7.5									
574-60140	63601410	14.0	Phelon	FG4128	1390134	2.5		40-55	Phelon FG3693	13800115	.15-.19
574-60340	63602810	28.0	Wico	X11352	36850113	2.0		45-60	Wico X11362	36850115	.26-.30
574-60360	63602830	28.0									
574-60540	63604530	45.0	McCul	Top	76089	1.4	.55-.85	45-60	Wico X11264	76067	.26-.30
574-60550	63604540	45.0	McCul	Bottom	76092	1.4	.55-.85	45-60	Wico X11264	76067	.26-.30
574-60541	63604531	45.0									
574-60551	63604541	45.0									
574-60740	63607530	75.0	McCul		76091	1.10	.6-.9	45-55	Wico X11264	76067	.26-.30
574-60750	63607540	75.0									
574-60741	63607531	75.0	McCul		76091	1.10	.6-.9	45-55		76066A	.25-.27
574-60751	63607541	75.0								76066A	.25-.27

FORWARD - REVERSE SHIFTING COIL

Model No.	Coil No.	Operating Amperage	Primary Resistance		Secondary Continuity	
			Min.	Max.	Min.	Max.

SU & HU 379519 Resistance Min. - 5.0 Max. - 6.0

EVINRUDE - JOHNSON - OMC ENGINES

580527 .6 .7 - .9 65 - 75

With Loose Pig-Tail Leads, Low Resistance Primary One OHM or Less

580602 .6 .7 - .9 65 - 75

Leads Attached with Black or Purple Cement, Low Primary Resistance One OHM or Less

580602 .5 2.5 - 3.0 70 - 80

Leads Attached with Dark Purple Cement. High Primary Resistance 2.5 to 3.5 OHMs.

Most Engines are using this Coil.

NOTE: When testing the above Coils, disconnect the Internal Battery and connect Leads to a 12-Volt Battery. Use 12-Volt External Battery for Power Test only.

CAUTION: Do NOT use the 12-Volt Battery for any other test.

379569-1-0XE11-OX .9 1.3 - 1.7 60 - 70

Capacity

Condenser Microfarads

Mfg. No. Min. Max.

OMC-580573 .18 - .22

GERMAN BOSCH

Coil No.	Operating Amperage	Primary Resistance		Secondary Continuity	
		Min.	Max.	Min.	Max.
TJ 12/1	.7	2.9	3.5	45	60
TK 12A3	.7	3.2	3.6	50	60

HONDA

Model No.	Coil No.	Oper. Amps	Primary Resistance		Secondary Continuity		
			Min.	Max.	Min.	Max.	
C100/C110	100-1801.3FND	1.7	.5	.6	35	45	
C102	C102-1806ND	1.15	1.4	1.6	55	65	
C200/CT200	C2004806AK	1.15	1.1	1.3	65	75	
C100/C110 C105T Energy Transformer	C110-4806ND	.5	4.4	4.6	55	65	
CB160	CB93-4806ND	.52	3.8	4.3	55	65	
CB72, CB77 CL72	CB721806A-ND	.60	3.8	4.2	50	60	
C100/C110 C105T	C100, 1801, 3KND	Resistance only Min. 1.4 Max. 1.6					

All Condensers are rated at Min. .21 and Max. .25.

NOTE: When testing Coil (C110-4806AK) disconnect the Internal Battery and connect Analyzer Leads to a 12 volt storage battery attaching our part no. 47-174 Suppressor in series with one side of the Battery Lead. Do not use the 12 volts for any other tests.

COIL SPECIFICATIONS

Model No.	H.P.	Mfgr.	Coil No.	Operating Amperage	Primary Resistance		Secondary Continuity	
					Min.	Max.	Min.	Max.
VH60 John Deere		Lauson	30560 (Replaces 30546)	1.5	.46	.56	50	60
HH80	8	Lauson	32014	1.4	.37	.45	55	65
HH100	10	Lauson	32014	1.4	.37	.45	55	65
HH120	12	Lauson	32014	1.4	.37	.45	55	65
			610706	1.8	.59	.65	55	65

CONDENSER SPEC.

Condenser No.	Capacity Microfarads	
	Min.	Max.
30548	.12	.14
30548-A	.16	.18
32015	.24	.27
610707	.19	.21
29177	.15	.19

KIEKHAEFER-MERCURY-MERCUISER

Coil No.	Operating Amperage	Primary Resistance		Secondary Continuity		Condenser No.	Capacity Microfarads	
		Min.	Max.	Min.	Max.		Min.	Max.
32704	.5	3.9	4.8	48	58	33662	.18	.25
26433	.9	.9	1.2	55	70	33706	.18	.25
38547	.5	3.9	4.8	48	58	37189	.24	.30
398-2545	2.0	4.5	5.5	35	45			
298-2568	1.8	4.5	5.5	40	60			

1965-66 McCULLOCH CORP. OUTBOARD MOTOR SPECIFICATIONS

Model No.	H.P.	Make	COIL NUMBER		Oper. Amp.	Primary Resistance		Secondary Continuity		CONDENSER NO.		Capacity Microfarad Min. Max.
			Mfg.	McCulloch		Min. Max.	Min. Max.	Mfg.	McCulloch			
65300710	7.5	Phelon	FG6001	76088	2.5		45 - 60	FG4477	76065		.15 - .19	
65300750	7.5	Phelon	FG6001	76088	2.5		45 - 60	FG4477	76065		.15 - .19	
65301410	14	Phelon	FG4128	1390134	2.5		40 - 55	FG3693	1380115		.15 - .19	
14000200	14	Phelon	FG4128	1390134	2.5		40 - 55	FG3693	1380115		.15 - .19	
65302810	28	Wico	X11135	36850113	2.0		45 - 60	X11362	36850115		.26 - .30	
65302830	28	McCul		TOP CYL								
				76089	1.4		45 - 60	X11264	76067		.26 - .30	
				BOTTOM								
				76092	1.4		45 - 60	X11264	76067		.26 - .30	
65304510	45	Wico	X11352	36850113	2.0		45 - 60	X11362	36850115		.26 - .30	
65304520	45	Wico	X11352	36850113	2.0		45 - 60	X11362	36850115		.26 - .30	
65304530	45	Andover		71230A	1.1	1.0 - 1.4	60 - 70	X11264	76067		.26 - .30	
65304540	45	Andover		71230A	1.1	1.0 - 1.4	60 - 70	X11264	76067		.26 - .30	
	45			73875	1.0	1.1 - 1.4	55 - 65					
65307530	75	Andover		75455	1.0	1.0 - 1.4	60 - 70	X11264	76066		.25 - .27	
65307543	75	Andover		75455	1.0	1.0 - 1.4	60 - 70	X11264	76066		.25 - .27	
	75			79670	.85	1.02 - 1.42	55 - 65		76066A		.18 - .22	
140-OX	14	Phelon	FG4128	1390134	2.5		40 - 55	FG3693	1380115		.15 - .19	
450-OX	45	Wico	X11352	36850113	2.0		45 - 60	X11262	36850115		.26 - .30	

McCULLOCH CORP. SUPPLEMENT SPECIFICATIONS FOR
CHAIN SAWS

H.P.	Stator Assy. No. McCulloch	Coil No. McCulloch	Operating Amperage	Primary		Secondary		Capacity	
				Continuity Min. Max.	Continuity Min. Max.	Continuity Min. Max.	Continuity Min. Max.	Condenser No. McCulloch	Microfarads Min. Max.
		62927(E65)	1.5	.7 - .8		55 - 65			
		79566	1.1	.6 - .8		45 - 55			
		C4	1.5	.48 - .55		45 - 55			
		79566(K4)	1.1	.6 - .8		45 - 55			
		76090	1.1	.6 - .9		45 - 55			
		76959	1.1	.6 - .9		45 - 55			
		76091	1.1	.6 - .9		45 - 55			
		PN71198A	.9	1.15 - 1.45		55 - 65			
		55949A C4	1.5	.48 - .55		45 - 55			
									(Corrected From 1962-3 Bulletin)

Same as Coil 79566 (K4)

TARGET AIR CRAFT ENGINE

Model 4318	10471(C65)	1.0	.4 - .5	42 - 52	X10455B	1008395	.18 - .23
------------	------------	-----	---------	---------	---------	---------	-----------

NOTE: 2 Coils mounted on one U shaped Lamination. Coils are connected in series. When testing, connect the 2 negative leads together. There is only one Positive Lead, two (2) High Tension Leads. Test each Coil separately by connecting High Tension Lead from Analyzer to each Coil.

ENGINE/GENERATOR DIVISION
ONAN STUDEBAKER CORPORATION

Model No.	Coil No.	Operating Amperage	Primary Resistance Min. Max.	Secondary Continuity Min. Max.	Condenser No.	Condenser Microfarads Min. Max.
CCK	160C792 Replaces 160C483 Prior Spec. "J"	.75	.7 - .8	50 - 60		
	166C346 Begin Spec. "J"	.9	.87 - 1.0	60 - 70		
	160K722 Stator Assy. Magneto (Coil)		.47 - .53			
	160K750	1.2	.45 - .51	50 - 60		
	160B750					
MCCK	166B382	.9	.85 - .95	60 - 70	31283	1.44 - 2.16
MJA	166B278	.5	3.0 - 3.5	50 - 60		
JA	166B278	.5	3.0 - 3.5	50 - 60		
MJB	160C792 Replaces 160C483 Prior Spec. "J"	.75	.7 - .8	50 - 60		
JB	166B278 Begin Spec. "J"	.5	3.0 - 3.5	50 - 60		
MJC	166B278	.5	3.0 - 3.5	50 - 60	312A116	.24 - .34
JC						

(See Page 21 Fig. 26 for Test Procedure)

NOTE: All Coils with Double Secondary Lead see Page 21 Fig. 26 for Test Procedure. We are unable to test Condenser #31283"

Coil No.	Operating Amperage	Primary Resistance		Secondary Continuity		Condenser No.	Capacity Microfarads	
		Min.	Max.	Min.	Max.		Min.	Max.
FG7168	2.0	.45	.55	35	50	FG3505	.16	.18
FG7202	1.8	.45	.55	40	60			
FG2435	2.8			50	60	FG3723	.16	.18
FG2503	2.8			50	60	FG4477	.16	.18
FG3289	2.8			50	60	FG5420A	.27	.33
FG3595	2.5			55	65	FG5420B	.27	.33
FG5380	2.5			60	70	FG6325	.25	.27
FG5395	2.5			60	70	FG6548B	.24	.27
FG6599	3.0			57	67	FG7047	.19	.21
FG7049	2.8			61	71	FG7130	.16	.18
FG7106B	2.5			60	70	FG7146	.19	.21
FG7151	2.8			61	71	FG7157	.16	.18
FG7202	2.4			53	63	FG7184	.25	.27
FG7256	2.8			61	71	FG7224	.16	.18
FG7271	2.6			57	67	FG7239	.19	.21
FG7423	2.1			52	62	FG7251	.12	.14
FG7427	2.1			52	62	FG7270	.16	.18
FG7447	2.6			57	67	FG7437	.13	.16
FG7459	2.6			57	67	FG7460	.16	.18
FG7469	2.25			60	70	FG7468	.12	.14
FG7502	2.7			54	64	FG7499	.16	.18
						FG7533	.13	.16

PIONEER CHAIN SAW

Model No.	Mfg.	Coil No.	Operating Amperage	Primary Resistance		Secondary Continuity	
				Min.	Max.	Min.	Max.
400	OMC	470685	1.4	.5	.7	40	55
600	Wico	X11180	1.8			35	55
700	OMC	580454	1.4	.4	.6	30	40
11-10	OMC	471365	1.3	.6	.7	50	60

Condenser Mfg. No.	Capacity Microfarads	
	Min.	Max.
426528	.18	.22
X11181	.16	.20
471354	.16	.20

PRESTOLITE (THE ELECTRIC AUTOLITE CO.)

Coil No.	Type	Operating Amperage	Primary Resistance		Secondary Continuity		Capacity Microfarads	
			Min.	Max.	Min.	Max.	Condenser No.	Min.
200668	Battery	.8	1.65	1.85	55	65		
200691	Battery	.57	3.5	3.9	55	65		
200692	Battery	.7	1.1	1.5	55	65		

Year - 1964

SEARS MOTORS

Sears No.	Model No.	H.P.	Mfg.	Coil No.	Sears No.	Oper. Amps	Primary Resistance		Secondary Resistance		Condenser Mfg.	Condenser No.	Sears No.	Capacity Micro. Min.-Max.
							Min.	Max.	Min.	Max.				
574-60030	64600310	3.5	Phelon	FG3689	1380134	2.5		40-60		Phelon	FG3693	1380115	.15-.19	
574-60100	64600710	7.5	Phelon	FG6001	76088	2.5		45-60		Phelon	FG4477	76065	.15-.19	
574-60150	64601410	14.0	Phelon	FG4128	1390134	2.5		40-55		Phelon	FG3693	1380115	.15-.19	
574-60370	64602810	28.0	Wico	X11352	36850113	2.0		45-60		Wico	X11362	36850115	.26-.30	
574-60380	64602830	28.0	McCul		76089-Top	1.4	.55-.85	45-60		Wico	X11264	76067	.26-.30	
574-60560	64604530	45.0	McCul		76092-Bot	1.4	.55-.85	45-60		Wico	X11264	76067	.26-.30	
574-60570	64604540	45.0	McCul		76092-Bot	1.4	.55-.85	45-60		Wico	X11264	76067	.26-.30	
574-60760	64607530	75.0	McCul		79566	1.10	.6-.9	45-55				76066A	.25-.27	
574-60770	64607540	75.0	McCul		79566	1.10	.6-.9	45-55				76066A	.25-.27	
574-60761	64607531	75.0	McCul		76090	1.10	.6-.9	45-55				76066A	.25-.27	
574-60771	64607541	75.0	McCul		76090	1.10	.6-.9	45-55				76066A	.25-.27	
574-60762	64607532	75.0	McCul		76091	1.10	.6-.9	45-55				76066A	.25-.27	
574-60772	64607542	75.0	McCul		76091	1.10	.6-.9	45-55				76066A	.25-.27	

Year-1965-66

574-60110	65600610	6.0	Phelon	FG6001	76088	2.5		45-60		Phelon	FG4477	76065	.15-.19
574-60120	65600710	7.5	Phelon	FG6001	76088	2.5		45-60		Phelon	FG4477	76065	.15-.19
574-60580	65604510	45.0	Andov		73875	1.0	1.1-1.4	55-65		Wico	X11264	76067	.26-.30
574-60780	65607530	75.0	McCul		79566	1.10	.6-.9	45-55				76066A	.25-.27
574-60790	65607540	75.0	McCul		79566	1.10	.6-.9	45-55				76066A	.25-.27
5929		2.0	Wico	X12660		1.8		40-55		Wico	X12174		.16-.20
5930		10.0	Wico	X11406		2.1		40-60		Wico	X11397		.16-.20
57159271		12.0	Wico	X14877		1.4	.4-.6	50-60		Wico	X11397		.16-.20
57159414		35.0	Fair	TX2477		1.5	.62-.68	45-55		Fair	S2433		.28-.32
57159415		35.0	Fair	TX2477		1.5	.62-.68	45-55		Fair	S2433		.28-.32

WICO

Coil No.	Type	Operating Amperage	Primary Resistance		Secondary Continuity		Condenser Mfg. No.	Used On Type	Capacity Microfarads Mini. Max.
			Min.	Max.	Min.	Max.			
X7895C	XH-2D	1.6	.5	.7	60	75	X9699	XHS	.26 - .30
X11477	FW	1.5	.45	.65	50	60	X14680	XHS	.30 - .34
X14877	FW	1.4	.4	.6	50	60	X16264	FW	.16 - .20
X16000	FW	1.3	.6	.7	50	60	X16329	FW	.16 - .20
X16330	FW	1.3	.6	.7	50	60	X16345	FW	.16 - .20
X16343	FW	1.3	.6	.7	50	60	X16410	FW	.16 - .20
X16381	FW	1.3	.6	.7	50	60	X30028B	DB	.18 - .23
X16398	FW	1.4	.4	.6	50	60	X30188B	DB (12 Volt)	.30 - .34
X6936B		1.55	.5	.65	45	55			
X11135		2.0			45	60			
X11563		.7	2.9	3.5	45	60			

(Correction From Page 28)

NOTE: When testing Coil X11563 (German Bosch #TJ 12/1 or TK 12A3), disconnect the Internal Battery and connect Analyzer Leads to a 12 Volt Storage Battery by attaching our Part No. 47-174 in series with one side of the Battery Lead. DO NOT use the 12 volts for any other tests.

Year - 1960

WIZARD MOTORS

Wizard No.	Model No.	H.P.	Mfg.	Coil No.	Wizard No.	Oper. Amps	Primary Resistance Min. Max.	Secondary Resistance Min. Max.	Condenser Mfg.	Condenser No.	Wizard No.	Capacity Micro. Min. Max.
MLM-6903A	A7BB	3.6	Phelon	FG3689	1380134	2.5		40-60	Phelon	FG3693	1380115	.15-.19
MLM-6908A	A7EB	7.5	McCul		1340134	2.5		40-60	Wico	X12293	1340115	.18-.22
	C7EB											
MLM-6912A	A7FB	12.0	Phelon	FG4128	1390134	2.5		40-55	Phelon	FG3693	1380115	.15-.19
MLM-6930A	A7GB	25.0	Wico	X11352	36850113	2.0		40-60	Wico	X11362	36850115	.26-.30
MLM-6932A	C7GB		McCul	436B-134	76096-Top	1.4	.55-.85	45-60	Wico	X11362	36850115	.26-.30
MLM-6933A	D7GB		McCul	336B-134	76095-Bot.	1.4	.55-.85	45-60	Wico	X11362	36850115	.26-.30
MLM-6944A	C7HB	40.0	McCul	436B-134	76096	1.4	.55-.85	45-60	Wico	X12264	76067	.26-.30
MLM-6945A	D7HB											
MLM-6960A	C7JB	60.0	McCul	C3JB-232	76159	1.4	.55-.85	45-60			76066	.25-.27
MLM-6961A	D7JB		McCul	C3JB-232	76159	1.4	.55-.85	45-60			76066	.25-.27
MLM-6960B	C7JB1	60.0										
MLM-6961B	D7JB1											

Year - 1961

MLM-6903B	61700310	3.6	Phelon	FG3689	1380134	2.5		40-60	Phelon	FG3693	1380115	.15-.19
MLM-6908C	61700710	7.5	Phelon	FG6001	76088	2.5		45-60	Phelon	FG4477	76065	.15-.19

Year - 1962

MLM-6903C	62700310	3.6	Phelon	FG6001	76088	2.5		45-60	Phelon	FG4477	76065	.15-.19
MLM-6914	62701410	14.0	Phelon	FG4128	1390134	2.5		40-55	Phelon	FG3693	1380115	.15-.19

Year - 1963

MLM-6904B	64700310	3.5	Phelon	FG3689	1380134	2.5		40-60	Phelon	FG3693	1380115	.15-.19
MLM-6909B	64700710	7.5	Phelon	FG6001	76088	2.5		45-60	Phelon	FG4477	76065	.15-.19
MLM-6915B	64701410	14.0	Phelon	FG4128	1390134	2.5		40-55	Phelon	FG3693	1380115	.15-.19

Year - 1964

MLM-6904B	64700310	3.5	Phelon	FG3689	1380134	2.5		40-60	Phelon	FG3693	1380115	.15-.19
MLM-6909B	64700710	7.5	Phelon	FG6001	76088	2.5		45-60	Phelon	FG4477	76065	.15-.19
MLM-6915B	64701410	14.0	Phelon	FG4128	1390134	2.5		40-55	Phelon	FG3693	1380115	.15-.19

INDEX

FOR

MERC-O-TRONIC

MODEL 88 & 98 MAGNETO IGNITION ANALYZER
(Operating Instructions)

Armature Ground Test.....	17
Automotive Type Coils.....	10
Breaker Point Test.....	15
Coil Continuity Test.....	8
Coil Ground Test.....	9
Coil Power Test.....	5
Coil High Speed Test.....	6
Coil Surface Insulation Test.....	7
Condenser Test.....	11-12-13-14-16
Continuity Test.....	19
Description; Service Notes and Operating Instructions.....	1-4
Distributor Rotor Test.....	22
Evinrude-Johnson Uni-charger or AC Generator-"Alternator".....	27-40
Field Winding Ground Test.....	25
Ground Armature or Field Winding.....	26
Ground Brush Test.....	25
High Tension Leakage-Grack Test.....	21
Resistance Test.....	19
Resistor or Ballist Test.....	20
Service Hints.....	43-44
Spark Test.....	18
Starter Solenoid Test.....	18
Testing Coil with Two Secondary.....	23
Testing Conventional Type Magnetos.....	23
Testing Seleium Rectifiers.....	24
Timing.....	16-17

COIL AND CONDENSER SPECIFICATIONS

AMC "Saber".....	72
American Bosch Coil.....	83-84-84A-84B
American Bosch Condenser.....	93
Atlas-"Royal".....	67-68
Auto Lite Condenser.....	93
Bendix Scintilla Coil and Condenser.....	33-34-35
Briggs & Stratton Coil and Condenser.....	39
Briggs & Stratton Power Charger Service Section in back of manual.....	1 thru 10

INDEX

MERC-O-TRONIC

MODEL 88 & 98 MAGNETO IGNITION ANALYZER

Clinton Machine Company.....	80
Commodore.....	58D
Continental Motor Coil and Condenser.....	81
Delco-Remy Condenser.....	93
Echlin Condenser.....	80
Edison-"Splitdorf" Coil.....	84-85
Eisemann Flywheel Coil.....	86-87-88
Elgin Outboard Motors..54-55-56-57-58-58A thru	58C
Evinrude Magneto Coil and Condenser.....	38
Fairbanks-Morse Coil and Condenser.....	31-32
Fedway-"Saber".....	73
Firestone.....	58D
Ford Products Condenser.....	93
Gale Products-"Buccaneer".....	47-48-49-49A-49B
Gambles-"Hiawatha".....	69-70-70A
Goodrich-"Sea Flyer".....	71
Goodyear-"Sea Bee".....	62-63-64
International Harvester Coil.....	85
J.I. Case Company Coil.....	84
Johnson Motor Coil and Condenser.....	37
Kiekhaefer-"Mercury".....	36
Kohler Coil.....	82
Lauson Power Products Coil and Condenser....	89-90
Lawn Boy Coil and Condenser.....	38
Mallory Electric Corp. Coil and Condenser...	91-92
McCulloch Chain Saw Coil and Condenser.....	81
McCulloch Corp.-Outboard Motor.....	40 thru 46E
Oliver Outboard Motor Coil and Condenser.....	82
Pioneer Chain Saw.....	38
Pioneer Gen-E-Motor Coil and Condenser.....	82
R. E. Phelon.....	30
Robert Bosch Coil.....	85
Service Hints.....	43-44
Spiegel's "Brooklure".....	65-66
Studebaker Corporation	
(D.W. Onan & Sons Coil and Condenser).....	79
Ward's-"Sea King".....	50-51-52-53-53A-53B
West Bend Industrial Engines.....	60D-61
West Bend Outboard Motors.....	59-60-60A thru 60C
Western Auto.....	70B
Wico Coil and Condenser.....	27-28-29
Wisconsin Motor Company.....	75-76-77-78
Wizard Outboard Motor.....	74

Supplement Specifications in back of manual